

∅22mm

YW Series Switches & Pilot Lights



IDEC CORPORATION

Innovative Design, Space-Saving, Safety, and Self-Cleaning Contacts

Emergency Stop Switches

Satisfy International Standards

- Safety Lock Mechanism

When the emergency stop signal has been generated during actuation of the emergency stop device, the emergency stop function shall be maintained until the emergency stop device is reset (disengaged) (IEC 60947-5-5, 6.2).

- Direct Opening Action

Even if the contacts are welded, NC contacts are forced to open and break the circuit (compliant to IEC 60947-5-1, Annex K, IEC 60947-5-5, 5.2).

- Safe Pushbutton Design

The pushbutton is designed to ensure that an object cannot become trapped between the mushroom button and the panel, disabling the button operation. In addition, the pushbutton is designed to prevent removal from the front of the panel (IEC 60947-5-5, 6.3.2).

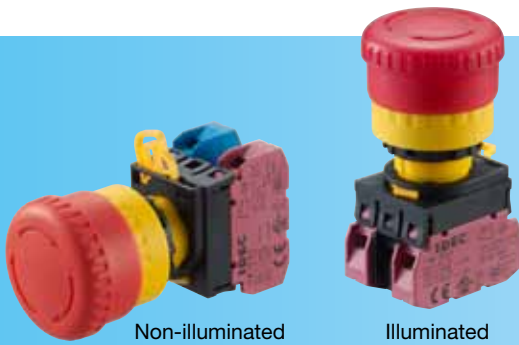

Easy Operation

- Push-to-lock, Pull/Turn-to-release

YW emergency stop switches can be unlatched by either pulling or turning the operator.

Unlatching by pulling



Unlatching by turning



Unibody Pilot Lights

Higher Brightness

Unibody pilot lights achieve high brightness.

Short Depth behind the Panel

Measures only 42mm depth behind the panel.

Four Lens Shapes

Flush, flush with marking, extended, and dome.

Panel Mounting

Unibody pilot lights can be mounted on panels by tightening the locking ring.



Key Selector Switches

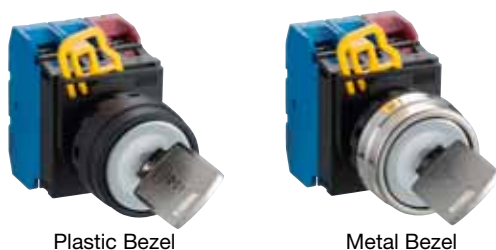

A variety of operations, key removal positions, and circuits.

Wide range adds more options to choose from.



Safety

Integrated Finger-safe Terminal Cover
Degree of Protection: IP20
(From panel front: IP65)

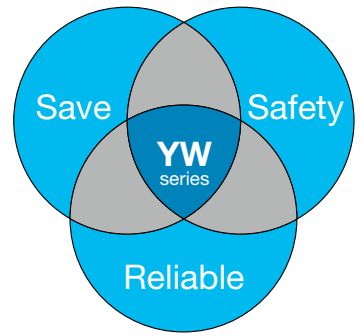

Save

New Contact Block Design
YW series

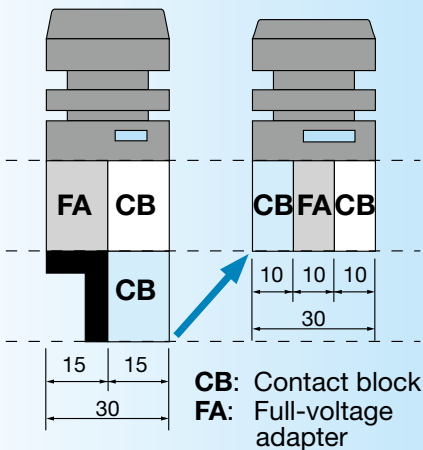

The contact block design reduces the depth behind the panel.



Metal bezels are available for pushbuttons, illuminated pushbuttons, selector switches, and key selector switches.



Reliable

Retained Locking Lever

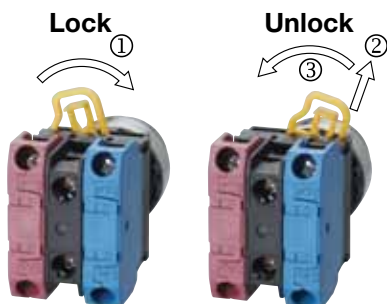

An innovative plastic locking lever is retained and eliminates the need for a separate lever lock.

Heavy-Duty Rugged Construction

Self-Cleaning Wiping-Action Contacts with Scored Contact Surfaces

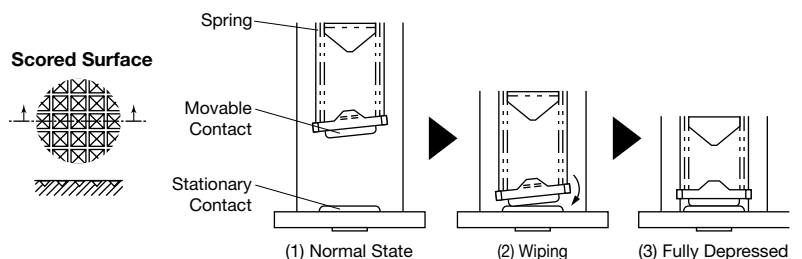

YW Series Switches & Pilot Lights

Space-saving, 10-mm-thick contact blocks. Removable operator.

- Compact and light-weight
- IP20 finger-safe screw terminals (IEC 60529)
- Emergency stop switches feature safety lock mechanism, direct opening action, and safe pushbutton design.
- Separate contact block makes installation and removal easy. Pilot lights feature a large lens for a wide viewing angle.
- Matted surfaces on the buttons, lenses, and bezels reduce reflection of ambient light.
- UL, c-UL listed, EN compliant, and CCC approved.



- UL508, CSA C22.2 No. 14, EN 60947-1, EN 60947-5-1, EN 60947-5-5, GB 14048.5

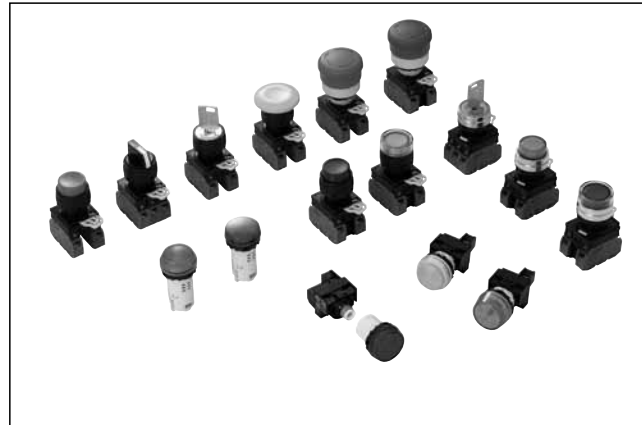

Contact Ratings (Contact Block)

Rated Insulation Voltage		600V			
Rated Thermal Current		10A			
Operating Voltage		24V	120V	240V	380V
AC 50/60 Hz	Resistive Load (AC-12)	10A	10A	6A	2A
	Inductive Load (AC-15)	10A	6A	3A	1.9A
DC	Resistive Load (DC-12)	8A	2.2A	1.1A	–
	Inductive Load (DC-13)	4A	1.1A	0.55A	–

LED Illuminated Unit Specifications

Pilot Light (removable lamp terminal type)

Illuminated Pushbutton

Unit				LED Lamp				
Unit Type	Input Type	Operating Voltage	Color Code	Lamp Base	Part No.	Rated Voltage	Current Draw	Color
Pilot Light (removable lamp terminal type)	Full Voltage	6V AC/DC	A: amber G: green PW: pure white R: red S: blue W: white (Note) Y: yellow	BA9S/13	LSED-6⊙	6V AC/DC	10mA (A, R, Y) 7mA (G, PW, S)	A: amber G: green PW: pure white R: red S: blue Y: yellow
		12V AC/DC			LSED-1⊙	12V AC/DC	14mA (A, R, Y) 13mA (G, PW, S)	
		24V AC/DC			LSED-2⊙	24V AC/DC	14mA (A, R, Y) 13mA (G, PW, S)	
		110V AC/DC			LSED-H⊙	110/120V AC/DC	5mA	
		230/240V AC/DC			LSED-M3⊙	230/240V AC/DC	3mA	
Illuminated Pushbutton	Transformer (pilot light only)	100/110V AC			LSED-6⊙	6V AC/DC	10mA (A, R, Y) 7mA (G, PW, S)	
		200/220V AC						
		115/120V AC 230/240V AC						

Note: Yellow LED lamps are used for white illumination.

Pilot Light (unibody type)

Unit Type	Operating Voltage	Current Draw	Color Code
Pilot Light (unibody type)	6V AC/DC	16mA (A, R, W, Y) 13mA (G, PW, S)	A: amber G: green PW: pure white R: red S: blue W: white Y: yellow
	12V AC/DC	20mA	
	24V AC/DC	20mA	
	110V AC/DC	20mA	
	230/240V AC/DC	20mA	

Incandescent Illuminated Unit Specifications

Pilot Light (removable lamp terminal type)

Illuminated Pushbutton

Unit				LED Lamp		
Unit Type	Input Type	Operating Voltage	Color Code	Lamp Base	Part No.	Rating
(Pilot Light (removable lamp terminal type)	Full Voltage	6V AC/DC	A: amber G: green R: red S: blue W: white Y: yellow	BA9S/13	LS-T6	1W (6.3V)
		12V AC/DC			LS-T8	1W (18V)
		24V AC/DC			LS-T3	1W (30V)
		100/110V AC				
Illuminated Pushbutton	Transformer (pilot light only)	200/220V AC			LS-T6	1W (6.3V)
		115/120V AC				
		230/240V AC				

Specifications

Operating Conditions	Operating temperature: -20 to +55°C (no freezing) Operating humidity: 45 to 85% RH (no condensation) Storage temperature: -45 to +80°C Storage humidity: 95% RH maximum
Degree of Protection	From panel front: IP65 (IEC 60529) Terminal: IP20 (IEC 60529)
Insulation Resistance	100 MΩ
Dielectric Strength	Contact block: 2,500V, 1 minute Pilot light: 2,000V, 1 minute
Vibration Resistance	<Emergency stop switch> Operating extremes / Damage limits: 10 to 500 Hz, amplitude 0.35 mm, acceleration 50 m/s ² (5G) <Pushbutton, pilot light, illuminated pushbutton, selector switch, and key selector switch> Operating extremes: 5 to 55 Hz, amplitude 0.5 mm Damage limits: 30 Hz, amplitude 1.5 mm
Shock Resistance	<Emergency stop switch> Operating extremes: 150 m/s ² (10G) Damage limits: 1,000 m/s ² (100G) <Pushbutton, pilot light, illuminated pushbutton, selector switch, and key selector switch> Operating extremes: 100 m/s ² (10G) Damage limits: 1,000 m/s ² (100G)
Mechanical Life (minimum operations)	<Emergency stop switch> 250,000 (single contact block) <Pushbutton and illuminated pushbutton> Momentary: 5,000,000 (single contact block) 1,000,000 (double contact block) Maintained: 250,000 (single contact block) 100,000 (double contact block) <Selector switch and key selector switch> 250,000 (single contact block) 100,000 (double contact block)
Electrical Life (minimum operations)	<Emergency stop switch> 100,000 (single contact block) <Pushbutton, selector switch, and key selector switch> 100,000 (single contact block) 50,000 (double contact block)

Mounting Hole Layout

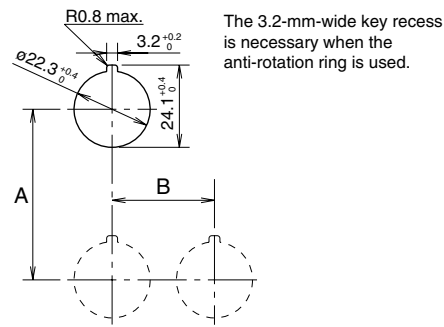



Unit	A (mm)	B (mm)
Emergency stop switch	50 min.	50 min.
Pushbutton		
Selector switch	50 min.	30 min.
Key selector switch		
Mushroom pushbutton	50 min.	40 min.
Pilot light (with removable lamp terminal)	30 min.*	30 min.
Pilot light (unibody)	50 min.	30 min.

* Keep a minimum spacing of 50 mm when using a lamp of over 1W.

ø22 YW Series Emergency Stop Switches

Emergency Stop Switches (Pushlock Pull/Turn Reset)

Package Quantity: 1

Style	Contact	Contact Block Mounting Position			Part No.	Button Color Code
		1	2	3		
 	1NC	—	—	NC	YW1B-V4E01R	Red only
	2NC	NC	—	NC	YW1B-V4E02R	
	3NC	NC	NC	NC	YW1B-V4E03R	
	1NO-1NC	NO	—	NC	YW1B-V4E11R	
	1NO-2NC	NO	NC	NC	YW1B-V4E12R	
	2NO-1NC	NO	NC	NO	YW1B-V4E21R	

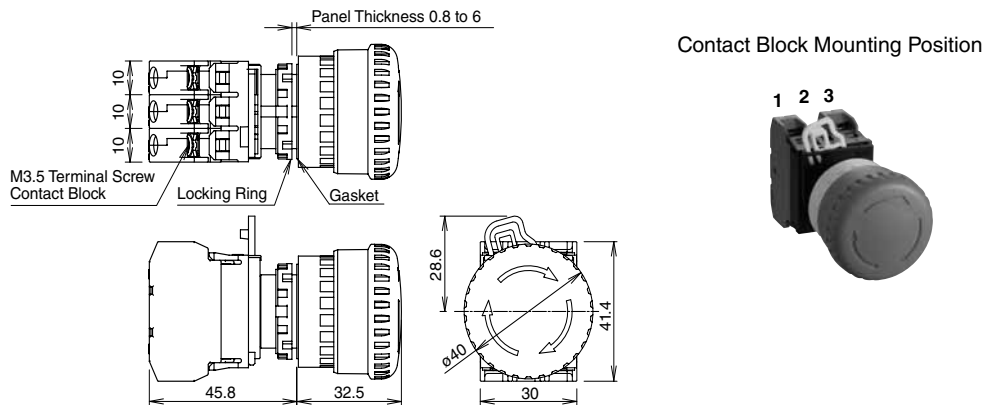

- When pressed, the button is locked in the depressed position, and is reset when either pulled or turned clockwise.

Dimensions



Illuminated Emergency Stop Switches (Pushlock Pull/Turn Reset)

Package Quantity: 1

Style	Lamp	Contacts	Contact Block Mounting Position			Part No.	③ Operating Voltage Code	Lens Color Code
			1	2	3			
 	Without Lamp	1NC	—	FA	NC	YW1L-V4E01Q0R	0: without lamp 250V AC/DC max.	Red only
		2NC	NC	FA	NC	YW1L-V4E02Q0R		
		1NO-1NC	NO	FA	NC	YW1L-V4E11Q0R		
	LED	1NC	—	FA	NC	YW1L-V4E01Q③R	2: 6V AC/DC 3: 12V AC/DC 4: 24V AC/DC H: 110V AC/DC M3: 230/240V AC/DC	
		2NC	NC	FA	NC	YW1L-V4E02Q③R		
		1NO-1NC	NO	FA	NC	YW1L-V4E11Q③R		
	Incandescent	1NC	—	FA	NC	YW1L-V4E01Q③R	5: 6V AC/DC 6: 12V AC/DC 7: 24V AC/DC	
		2NC	NC	FA	NC	YW1L-V4E02Q③R		
		1NO-1NC	NO	FA	NC	YW1L-V4E11Q③R		

- Specify an operating voltage code in place of ③ in the Part No.
- When pressed, the button is locked in the depressed position, and is reset when either pulled or turned clockwise.





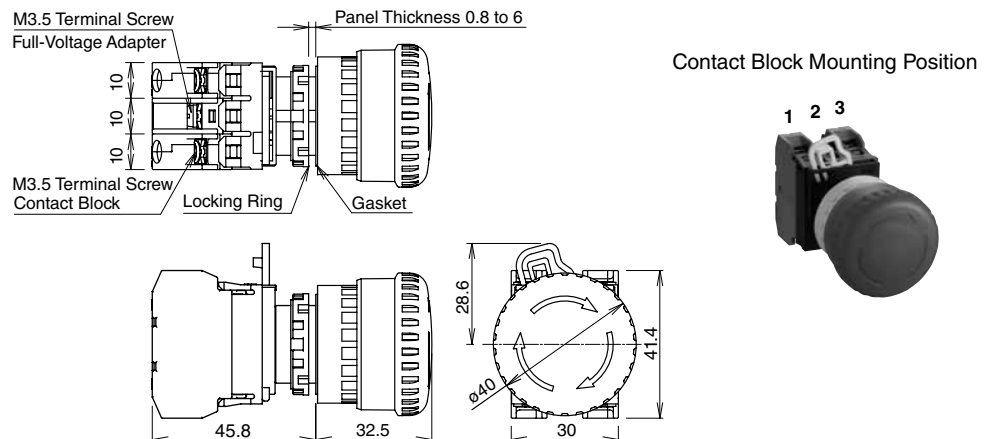

FA: Full voltage adapter

Dimensions



Pushbuttons with Plastic Bezel

Package Quantity: 1

Shape	Operation	Contact	Contact Block Mounting Position			Part No.	① Button Color Code			
			1	2	3					
 	Momentary	1NO	NO	—	—	YW1B-M1E10①	B: black G: green R: red S: blue W: white Y: yellow			
		1NC	—	—	NC	YW1B-M1E01①				
		2NO	NO	—	NO	YW1B-M1E20①				
		2NC	NC	—	NC	YW1B-M1E02①				
		1NO-1NC	NO	—	NC	YW1B-M1E11①				
		3NO	NO	NO	NO	YW1B-M1E30①				
		3NC	NC	NC	NC	YW1B-M1E03①				
	Maintained	2NO-1NC	NO	NC	NO	YW1B-M1E21①				
		1NO-2NC	NO	NC	NC	YW1B-M1E12①				
		1NO	NO	—	—	YW1B-A1E10①				
		1NC	—	—	NC	YW1B-A1E01①				
		2NO	NO	—	NO	YW1B-A1E20①				
		2NC	NC	—	NC	YW1B-A1E02①				
		1NO-1NC	NO	—	NC	YW1B-A1E11①				
 	Momentary	1NO	NO	—	—	YW1B-M2E10①	B: black G: green R: red S: blue W: white Y: yellow			
		1NC	—	—	NC	YW1B-M2E01①				
		2NO	NO	—	NO	YW1B-M2E20①				
		2NC	NC	—	NC	YW1B-M2E02①				
		1NO-1NC	NO	—	NC	YW1B-M2E11①				
	Maintained	1NO	NO	—	—	YW1B-A2E10①				
		1NC	—	—	NC	YW1B-A2E01①				
		2NO	NO	—	NO	YW1B-A2E20①				
		2NC	NC	—	NC	YW1B-A2E02①				
		1NO-1NC	NO	—	NC	YW1B-A2E11①				
		 	Momentary	1NO	NO	—		—	YW1B-M4E10①	B: black G: green R: red S: blue W: white Y: yellow
				1NC	—	—		NC	YW1B-M4E01①	
				2NO	NO	—		NO	YW1B-M4E20①	
				2NC	NC	—		NC	YW1B-M4E02①	
1NO-1NC	NO			—	NC	YW1B-M4E11①				
Maintained	1NO		NO	—	—	YW1B-A4E10①				
	1NC		—	—	NC	YW1B-A4E01①				
	2NO		NO	—	NO	YW1B-A4E20①				
	2NC		NC	—	NC	YW1B-A4E02①				
	1NO-1NC	NO	—	NC	YW1B-A4E11①					

Note: Specify a button color code in place of ① in the Part No.

Dimensions

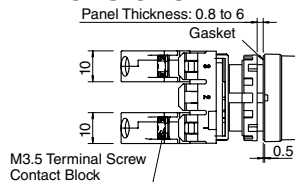

Contact Block Mounting Position



Flush

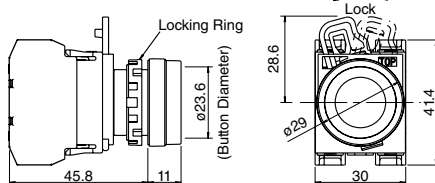

Extended

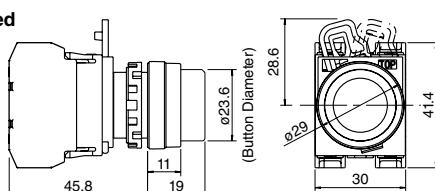

Mushroom

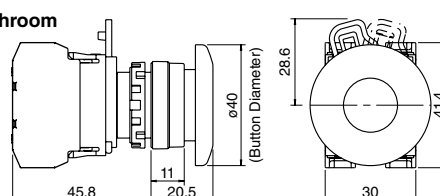







All dimensions in mm.

ø22 YW Series Pushbuttons

Pushbuttons with Metal Bezel

Package Quantity: 1

Shape	Operation	Contact	Contact Block Mounting Position			Part No.	① Button Color Code			
			1	2	3					
 	Momentary	1NO	NO	—	—	YW4B-M1E10①	B: black G: green R: red S: blue W: white Y: yellow			
		1NC	—	—	NC	YW4B-M1E01①				
		2NO	NO	—	NO	YW4B-M1E20①				
		2NC	NC	—	NC	YW4B-M1E02①				
		1NO-1NC	NO	—	NC	YW4B-M1E11①				
		3NO	NO	NO	NO	YW4B-M1E30①				
		3NC	NC	NC	NC	YW4B-M1E03①				
	Maintained	2NO-1NC	NO	NC	NO	YW4B-M1E21①				
		1NO-2NC	NO	NC	NC	YW4B-M1E12①				
		1NO	NO	—	—	YW4B-A1E10①				
		1NC	—	—	NC	YW4B-A1E01①				
		2NO	NO	—	NO	YW4B-A1E20①				
		2NC	NC	—	NC	YW4B-A1E02①				
		1NO-1NC	NO	—	NC	YW4B-A1E11①				
 	Momentary	1NO	NO	—	—	YW4B-M2E10①	B: black G: green R: red S: blue W: white Y: yellow			
		1NC	—	—	NC	YW4B-M2E01①				
		2NO	NO	—	NO	YW4B-M2E20①				
		2NC	NC	—	NC	YW4B-M2E02①				
	Maintained	1NO-1NC	NO	—	NC	YW4B-M2E11①				
		1NO	NO	—	—	YW4B-A2E10①				
		1NC	—	—	NC	YW4B-A2E01①				
		2NO	NO	—	NO	YW4B-A2E20①				
		2NC	NC	—	NC	YW4B-A2E02①				
		1NO-1NC	NO	—	NC	YW4B-A2E11①				
		 	Momentary	1NO	NO	—		—	YW4B-M4E10①	B: black G: green R: red S: blue W: white Y: yellow
				1NC	—	—		NC	YW4B-M4E01①	
				2NO	NO	—		NO	YW4B-M4E20①	
				2NC	NC	—		NC	YW4B-M4E02①	
Maintained	1NO-1NC		NO	—	NC	YW4B-M4E11①				
	1NO		NO	—	—	YW4B-A4E10①				
	1NC		—	—	NC	YW4B-A4E01①				
	2NO		NO	—	NO	YW4B-A4E20①				
	2NC		NC	—	NC	YW4B-A4E02①				
	1NO-1NC		NO	—	NC	YW4B-A4E11①				

Note: Specify a button color code in place of ① in the Part No.

Dimensions

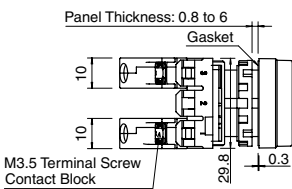

Flush

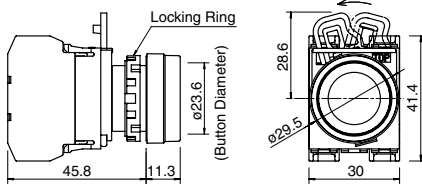

Extended

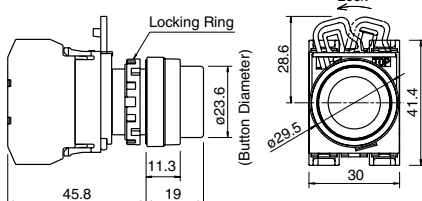

Mushroom

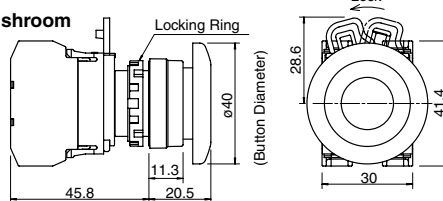





Contact Block Mounting Position



All dimensions in mm.

Pilot Lights (Unibody)

Package Quantity: 1

Shape	Lamp	Operating Voltage	Part No.	② Lens Color Code
Flush Full Voltage 	LED	6V AC/DC	YW1P-1UQ2②	A: amber G: green PW: pure white R: red S: blue W: white Y: yellow
		12V AC/DC	YW1P-1UQ3②	
		24V AC/DC	YW1P-1UQ4②	
		100/110V AC	YW1P-1UQH②	
		230/240V AC	YW1P-1UQM3②	
Flush Marking Full Voltage 	LED	6V AC/DC	YW1P-1BUQ2②	
		12V AC/DC	YW1P-1BUQ3②	
		24V AC/DC	YW1P-1BUQ4②	
		100/110V AC	YW1P-1BUQH②	
		230/240V AC	YW1P-1BUQM3②	
Extended Full Voltage 	LED	6V AC/DC	YW1P-2TUQ2②	
		12V AC/DC	YW1P-2TUQ3②	
		24V AC/DC	YW1P-2TUQ4②	
		100/110V AC	YW1P-2TUQH②	
		230/240V AC	YW1P-2TUQM3②	
Dome Full Voltage 	LED	6V AC/DC	YW1P-2UQ2②	
		12V AC/DC	YW1P-2UQ3②	
		24V AC/DC	YW1P-2UQ4②	
		100/110V AC	YW1P-2UQH②	
		230/240V AC	YW1P-2UQM3②	

Dimensions

Flush

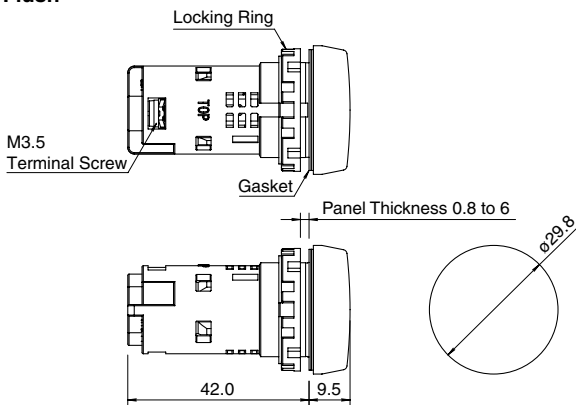

Flush Marking

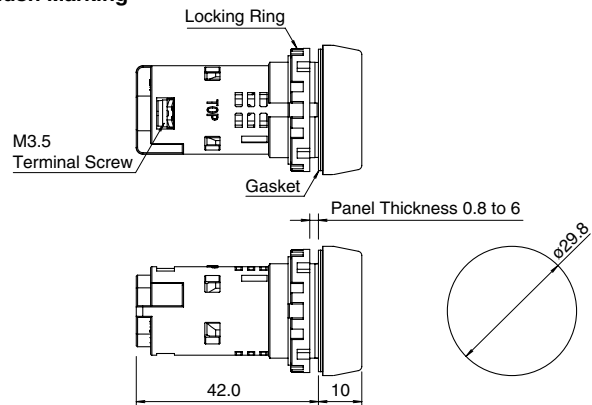

Extended

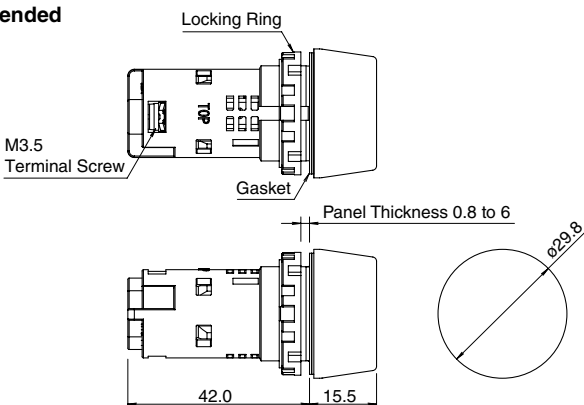

Dome

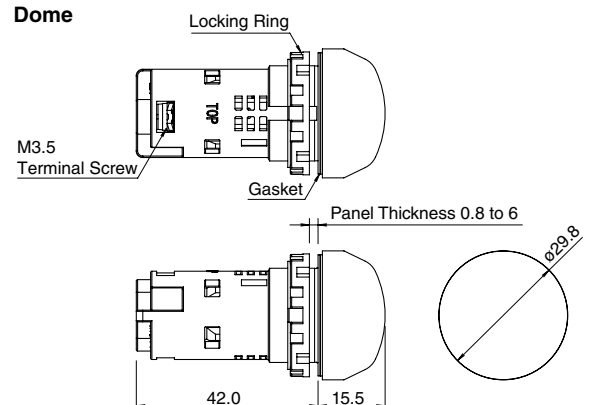

All dimensions in mm.

ø22 YW Series Pilot Lights

Pilot Lights (with Removable Lamp Terminal)

Package Quantity: 1

Shape	Lamp	Operating Voltage	Part No.	② Lens Color Code	
Flush Full Voltage 	Without Lamp	250V AC/DC max.	YW1P-1EQ0 ②	A (amber), C (clear), G (green), R (red), S (blue), W (white), Y (yellow)	
		LED	6V AC/DC	YW1P-1EQ2 ②	A (amber), G (green), PW (pure white), R (red), S (blue), W (white), Y (yellow) Built-in LED lamp: LSED-③②
	12V AC/DC		YW1P-1EQ3 ②		
	24V AC/DC		YW1P-1EQ4 ②		
	110V AC/DC		YW1P-1EQH ②		
	230/240V AC/DC		YW1P-1EQM3 ②		
	Incandescent	6V AC/DC	YW1P-1EQ5 ②	A (amber), C (clear), G (green), R (red), S (blue), W (white), Y (yellow) Built-in incandescent lamp: LS-T③	
		12V AC/DC	YW1P-1EQ6 ②		
		24V AC/DC	YW1P-1EQ7 ②		
	Flush Transformer 	LED	100/110V AC	YW1P-1EH2 ②	A (amber), G (green), PW (pure white), R (red), S (blue), W (white), Y (yellow) Built-in LED lamp: LSED-6②
200/220V AC			YW1P-1EM2 ②		
115/120V AC			YW1P-1EH22 ②		
230/240V AC			YW1P-1EM42 ②		
Incandescent		100/110V AC	YW1P-1EH5 ②	A (amber), C (clear), G (green), R (red), S (blue), W (white), Y (yellow) Built-in incandescent lamp: LS-T6	
		200/220V AC	YW1P-1EM5 ②		
		115/120V AC	YW1P-1EH25 ②		
		230/240V AC	YW1P-1EM45 ②		
Flush Marking Full Voltage 		Without Lamp	250V AC/DC max.	YW1P-1BEQ0 ②	A (amber), G (green), R (red), S (blue), W (white), Y (yellow)
			LED	6V AC/DC	YW1P-1BEQ2 ②
	12V AC/DC	YW1P-1BEQ3 ②			
	24V AC/DC	YW1P-1BEQ4 ②			
	110V AC/DC	YW1P-1BEQH ②			
	230/240V AC/DC	YW1P-1BEQM3 ②			
	Incandescent	6V AC/DC	YW1P-1BEQ5 ②	A (amber), G (green), R (red), S (blue), W (white), Y (yellow) Built-in incandescent lamp: LS-T③	
		12V AC/DC	YW1P-1BEQ6 ②		
		24V AC/DC	YW1P-1BEQ7 ②		
	Flush Marking Transformer 	LED	100/110V AC	YW1P-1BEH2 ②	A (amber), G (green), PW (pure white), R (red), S (blue), W (white), Y (yellow) Built-in LED lamp: LSED-6②
200/220V AC			YW1P-1BEM2 ②		
115/120V AC			YW1P-1BEH22 ②		
230/240V AC			YW1P-1BEM42 ②		
Incandescent		100/110V AC	YW1P-1BEH5 ②	A (amber), G (green), R (red), S (blue), W (white), Y (yellow) Built-in incandescent lamp: LS-T6	
		200/220V AC	YW1P-1BEM5 ②		
		115/120V AC	YW1P-1BEH25 ②		
		230/240V AC	YW1P-1BEM45 ②		

Note: Specify a lens color code in place of ② in the Part No.
Clear lenses are used for PW (pure white) illumination of pilot lights.

YW Series Pilot Lights ø22

Shape	Lamp	Operating Voltage	Part No.	② Lens Color Code
Extended Full Voltage  	Without Lamp	250V AC/DC max.	YW1P-2TEQ0 ②	A (amber), C (clear), G (green), R (red), S (blue), W (white), Y (yellow)
	LED	6V AC/DC	YW1P-2TEQ2 ②	A (amber), G (green), PW (pure white), R (red), S (blue), W (white), Y (yellow) Built-in LED lamp: LSED-3②
		12V AC/DC	YW1P-2TEQ3 ②	
		24V AC/DC	YW1P-2TEQ4 ②	
		110V AC/DC	YW1P-2TEQH ②	
		230/240V AC/DC	YW1P-2TEQM3 ②	
	Incandescent	6V AC/DC	YW1P-2TEQ5 ②	A (amber), C (clear), G (green), R (red), S (blue), W (white), Y (yellow) Built-in incandescent lamp: LS-T③
		12V AC/DC	YW1P-2TEQ6 ②	
		24V AC/DC	YW1P-2TEQ7 ②	
	Extended Transformer  	LED	100/110V AC	YW1P-2TEH2 ②
200/220V AC			YW1P-2TEM2 ②	
115/120V AC			YW1P-2TEH22 ②	
230/240V AC			YW1P-2TEM42 ②	
Incandescent		100/110V AC	YW1P-2TEH5 ②	A (amber), C (clear), G (green), R (red), S (blue), W (white), Y (yellow) Built-in incandescent lamp: LS-T6
		200/220V AC	YW1P-2TEM5 ②	
		115/120V AC	YW1P-2TEH25 ②	
		230/240V AC	YW1P-2TEM45 ②	
Dome Full Voltage  	Without Lamp	250V AC/DC max.	YW1P-2EQ0 ②	A (amber), C (clear), G (green), R (red), S (blue), W (white), Y (yellow)
	LED	6V AC/DC	YW1P-2EQ2 ②	A (amber), G (green), PW (pure white), R (red), S (blue), W (white), Y (yellow) Built-in LED lamp: LSED-3②
		12V AC/DC	YW1P-2EQ3 ②	
		24V AC/DC	YW1P-2EQ4 ②	
		110V AC/DC	YW1P-2EQH ②	
		230/240V AC/DC	YW1P-2EQM3 ②	
	Incandescent	6V AC/DC	YW1P-2EQ5 ②	A (amber), C (clear), G (green), R (red), S (blue), W (white), Y (yellow) Built-in incandescent lamp: LS-T③
		12V AC/DC	YW1P-2EQ6 ②	
		24V AC/DC	YW1P-2EQ7 ②	
	Dome Transformer  	LED	100/110V AC	YW1P-2EH2 ②
200/220V AC			YW1P-2EM2 ②	
115/120V AC			YW1P-2EH22 ②	
230/240V AC			YW1P-2EM42 ②	
Incandescent		100/110V AC	YW1P-2EH5 ②	A (amber), C (clear), G (green), R (red), S (blue), W (white), Y (yellow) Built-in incandescent lamp: LS-T6
		200/220V AC	YW1P-2EM5 ②	
		115/120V AC	YW1P-2EH25 ②	
		230/240V AC	YW1P-2EM45 ②	

Note: Specify a lens color code in place of ② in the Part No.
Clear lenses are used for PW (pure white) illumination of pilot lights.

ø22 YW Series Pilot Lights

Dimensions (Pilot Lights with Removable Lamp Terminal)

Flush

Full Voltage

Panel Thickness 0.8 to 6

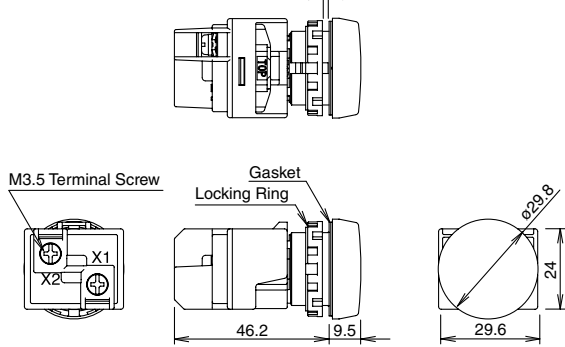

Transformer

Panel Thickness 0.8 to 6

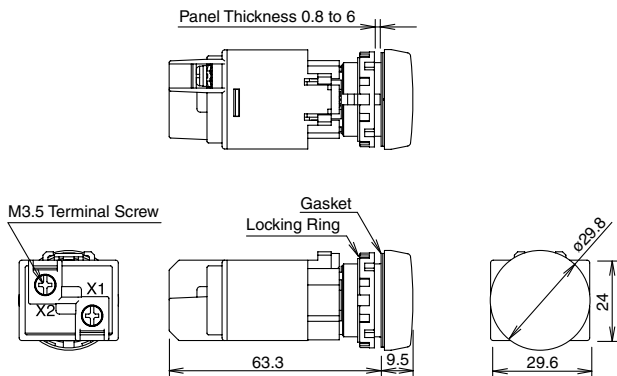

Flush Marking

Full Voltage

Panel Thickness 0.8 to 6

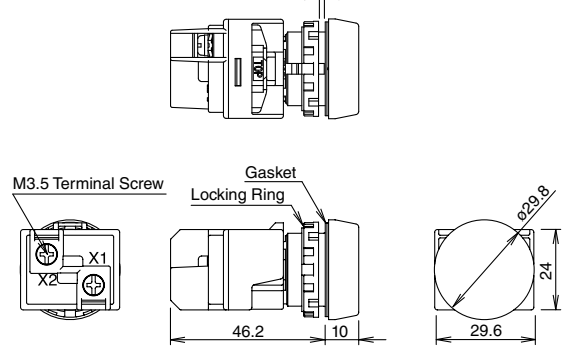

Transformer

Panel Thickness 0.8 to 6

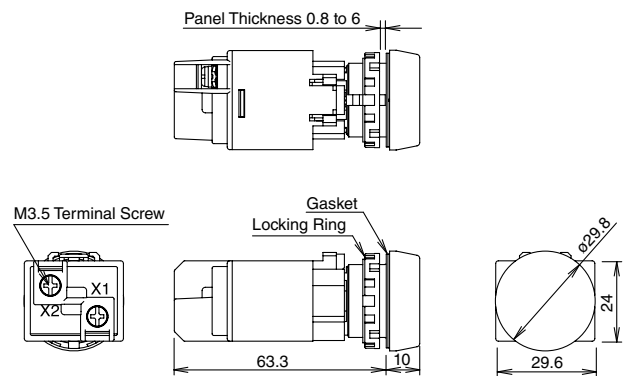

Extended

Full Voltage

Panel Thickness 0.8 to 6

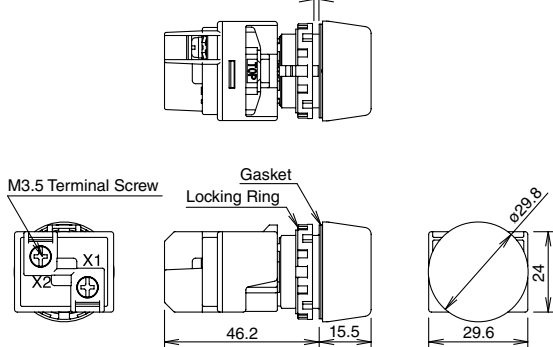

Transformer

Panel Thickness 0.8 to 6

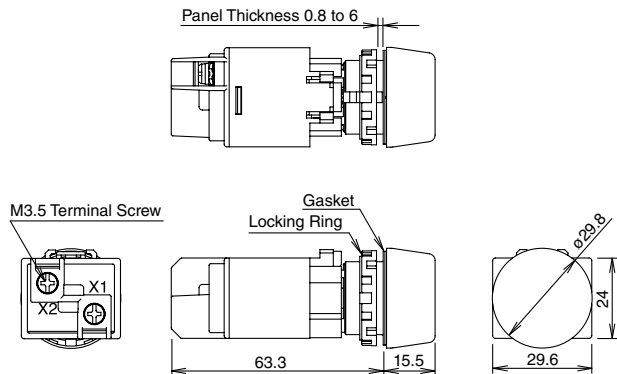

Dome

Full Voltage

Panel Thickness 0.8 to 6

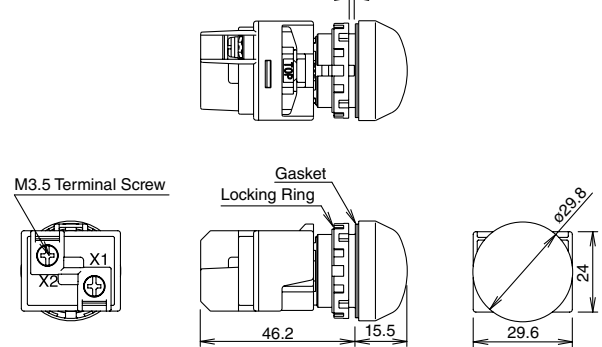

Transformer

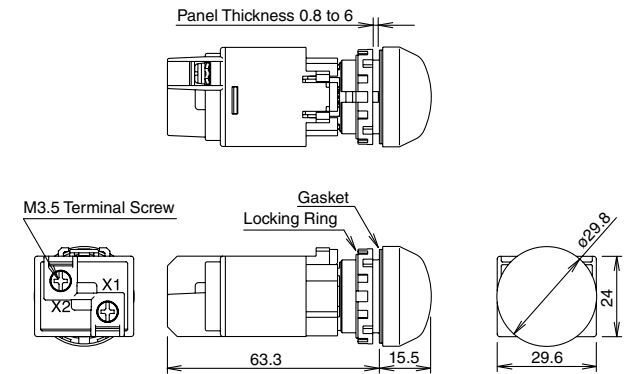

Panel Thickness 0.8 to 6



YW Series Illuminated Pushbuttons ø22

Illuminated Pushbuttons with Plastic Bezel

Package Quantity: 1

Shape	Lamp	Operation	Contact	Contact Block Mounting Position			Part No.	③ Operating Voltage Code	② Lens Color Code			
				1	2	3						
	Without Lamp	Momentary	1NO	NO	FA	—	YW1L-M2E10Q0 ②	0: without lamp 250V AC/DC max.	A: amber G: green R: red S: blue W: white Y: yellow			
			1NC	—	FA	NC	YW1L-M2E01Q0 ②					
			2NO	NO	FA	NO	YW1L-M2E20Q0 ②					
			2NC	NC	FA	NC	YW1L-M2E02Q0 ②					
		1NO-1NC	NO	FA	NC	YW1L-M2E11Q0 ②						
		Maintained	1NO	NO	FA	—	YW1L-A2E10Q0 ②					
			1NC	—	FA	NC	YW1L-A2E01Q0 ②					
			2NO	NO	FA	NO	YW1L-A2E20Q0 ②					
			2NC	NC	FA	NC	YW1L-A2E02Q0 ②					
		1NO-1NC	NO	FA	NC	YW1L-A2E11Q0 ②						
		LED	Momentary	1NO	NO	FA	—			YW1L-M2E10Q ③②	2: 6V AC/DC 3: 12V AC/DC 4: 24V AC/DC H: 110V AC/DC M3: 230/240V AC/DC	A: amber G: green PW: pure white R: red S: blue W: white Y: yellow Built-in LED lamp: LSED-③②
				1NC	—	FA	NC			YW1L-M2E01Q ③②		
	2NO			NO	FA	NO	YW1L-M2E20Q ③②					
	2NC			NC	FA	NC	YW1L-M2E02Q ③②					
	1NO-1NC		NO	FA	NC	YW1L-M2E11Q ③②						
	Maintained		1NO	NO	FA	—	YW1L-A2E10Q ③②					
			1NC	—	FA	NC	YW1L-A2E01Q ③②					
			2NO	NO	FA	NO	YW1L-A2E20Q ③②					
			2NC	NC	FA	NC	YW1L-A2E02Q ③②					
	1NO-1NC		NO	FA	NC	YW1L-A2E11Q ③②						
	Incandescent		Momentary	1NO	NO	FA	—	YW1L-M2E10Q ③②	5: 6V AC/DC 6: 12V AC/DC 7: 24V AC/DC	A: amber G: green R: red S: blue W: white Y: yellow Built-in incandescent lamp: LS-T③		
				1NC	—	FA	NC	YW1L-M2E01Q ③②				
		2NO		NO	FA	NO	YW1L-M2E20Q ③②					
		2NC		NC	FA	NC	YW1L-M2E02Q ③②					
1NO-1NC		NO	FA	NC	YW1L-M2E11Q ③②							
Maintained		1NO	NO	FA	—	YW1L-A2E10Q ③②						
		1NC	—	FA	NC	YW1L-A2E01Q ③②						
		2NO	NO	FA	NO	YW1L-A2E20Q ③②						
		2NC	NC	FA	NC	YW1L-A2E02Q ③②						
1NO-1NC		NO	FA	NC	YW1L-A2E11Q ③②							
		Without Lamp	Momentary	1NO	NO	FA	—	YW1L-MF2E10Q0 ②			0: without lamp 250V AC/DC max.	A: amber G: green R: red S: blue W: white Y: yellow
				1NC	—	FA	NC	YW1L-MF2E01Q0 ②				
	2NO			NO	FA	NO	YW1L-MF2E20Q0 ②					
	2NC			NC	FA	NC	YW1L-MF2E02Q0 ②					
	1NO-1NC		NO	FA	NC	YW1L-MF2E11Q0 ②						
	Maintained		1NO	NO	FA	—	YW1L-AF2E10Q0 ②					
			1NC	—	FA	NC	YW1L-AF2E01Q0 ②					
			2NO	NO	FA	NO	YW1L-AF2E20Q0 ②					
			2NC	NC	FA	NC	YW1L-AF2E02Q0 ②					
	1NO-1NC		NO	FA	NC	YW1L-AF2E11Q0 ②						
	LED		Momentary	1NO	NO	FA	—	YW1L-MF2E10Q ③②	2: 6V AC/DC 3: 12V AC/DC 4: 24V AC/DC H: 110V AC/DC M3: 230/240V AC/DC	A: amber G: green PW: pure white R: red S: blue W: white Y: yellow Built-in LED lamp: LSED-③②		
				1NC	—	FA	NC	YW1L-MF2E01Q ③②				
		2NO		NO	FA	NO	YW1L-MF2E20Q ③②					
		2NC		NC	FA	NC	YW1L-MF2E02Q ③②					
		1NO-1NC	NO	FA	NC	YW1L-MF2E11Q ③②						
		Maintained	1NO	NO	FA	—	YW1L-AF2E10Q ③②					
			1NC	—	FA	NC	YW1L-AF2E01Q ③②					
			2NO	NO	FA	NO	YW1L-AF2E20Q ③②					
			2NC	NC	FA	NC	YW1L-AF2E02Q ③②					
		1NO-1NC	NO	FA	NC	YW1L-AF2E11Q ③②						
		Incandescent	Momentary	1NO	NO	FA	—	YW1L-MF2E10Q ③②			5: 6V AC/DC 6: 12V AC/DC 7: 24V AC/DC	A: amber G: green R: red S: blue W: white Y: yellow Built-in incandescent lamp: LS-T③
				1NC	—	FA	NC	YW1L-MF2E01Q ③②				
	2NO			NO	FA	NO	YW1L-MF2E20Q ③②					
	2NC			NC	FA	NC	YW1L-MF2E02Q ③②					
1NO-1NC	NO		FA	NC	YW1L-MF2E11Q ③②							
Maintained	1NO		NO	FA	—	YW1L-AF2E10Q ③②						
	1NC		—	FA	NC	YW1L-AF2E01Q ③②						
	2NO		NO	FA	NO	YW1L-AF2E20Q ③②						
	2NC		NC	FA	NC	YW1L-AF2E02Q ③②						
1NO-1NC	NO		FA	NC	YW1L-AF2E11Q ③②							

Note: Specify a lens color code in place of ② in the Part No.
Specify an operating voltage code in place of ③ in the Part No.

FA: Full voltage adapter

ø22 YW Series Illuminated Pushbuttons

Shape	Lamp	Operation	Contact	Contact Block Mounting Position			Part No.	③ Operating Voltage Code	② Lens Color Code
				1	2	3			
	Without Lamp	Momentary	1NO	NO	FA	—	YW1L-M4E10Q0②	0: without lamp 250V AC/DC max.	A: amber G: green R: red S: blue W: white Y: yellow
			1NC	—	FA	NC	YW1L-M4E01Q0②		
			2NO	NO	FA	NO	YW1L-M4E20Q0②		
			2NC	NC	FA	NC	YW1L-M4E02Q0②		
			1NO-1NC	NO	FA	NC	YW1L-M4E11Q0②		
			1NO-1NC	NO	FA	NC	YW1L-M4E11Q0②		
		Maintained	1NO	NO	FA	—	YW1L-A4E10Q0②		
			1NC	—	FA	NC	YW1L-A4E01Q0②		
			2NO	NO	FA	NO	YW1L-A4E20Q0②		
			2NC	NC	FA	NC	YW1L-A4E02Q0②		
			1NO-1NC	NO	FA	NC	YW1L-A4E11Q0②		
			1NO-1NC	NO	FA	NC	YW1L-A4E11Q0②		
	LED	Momentary	1NO	NO	FA	—	YW1L-M4E10Q③②	2: 6V AC/DC 3: 12V AC/DC 4: 24V AC/DC H: 110V AC/DC M3: 230/240V AC/DC	A: amber G: green R: red PW: pure white S: blue W: white Y: yellow Built-in LED lamp: LSED-③②
			1NC	—	FA	NC	YW1L-M4E01Q③②		
			2NO	NO	FA	NO	YW1L-M4E20Q③②		
			2NC	NC	FA	NC	YW1L-M4E02Q③②		
			1NO-1NC	NO	FA	NC	YW1L-M4E11Q③②		
			1NO-1NC	NO	FA	NC	YW1L-M4E11Q③②		
		Maintained	1NO	NO	FA	—	YW1L-A4E10Q③②		
			1NC	—	FA	NC	YW1L-A4E01Q③②		
			2NO	NO	FA	NO	YW1L-A4E20Q③②		
			2NC	NC	FA	NC	YW1L-A4E02Q③②		
			1NO-1NC	NO	FA	NC	YW1L-A4E11Q③②		
			1NO-1NC	NO	FA	NC	YW1L-A4E11Q③②		
Incandescent	Momentary	1NO	NO	FA	—	YW1L-M4E10Q③②	5: 6V AC/DC 6: 12V AC/DC 7: 24V AC/DC	A: amber G: green R: red S: blue W: white Y: yellow Built-in incandescent lamp: LS-T③	
		1NC	—	FA	NC	YW1L-M4E01Q③②			
		2NO	NO	FA	NO	YW1L-M4E20Q③②			
		2NC	NC	FA	NC	YW1L-M4E02Q③②			
		1NO-1NC	NO	FA	NC	YW1L-M4E11Q③②			
		1NO-1NC	NO	FA	NC	YW1L-M4E11Q③②			
	Maintained	1NO	NO	FA	—	YW1L-A4E10Q③②			
		1NC	—	FA	NC	YW1L-A4E01Q③②			
		2NO	NO	FA	NO	YW1L-A4E20Q③②			
		2NC	NC	FA	NC	YW1L-A4E02Q③②			
		1NO-1NC	NO	FA	NC	YW1L-A4E11Q③②			
		1NO-1NC	NO	FA	NC	YW1L-A4E11Q③②			



Note: Specify a lens color code in place of ② in the Part No.
Specify an operating voltage code in place of ③ in the Part No.

FA: Full voltage adapter

Dimensions (Illuminated Pushbuttons with Plastic Bezel)

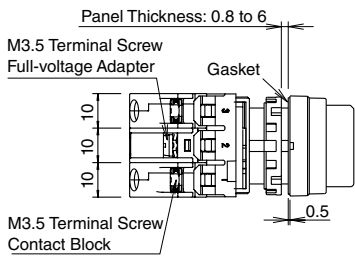

Contact Block Mounting Position



Extended

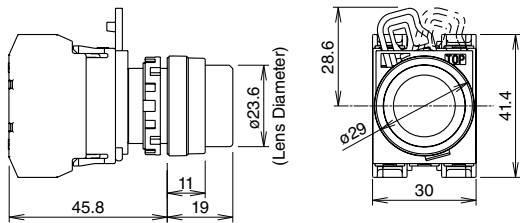

Mushroom

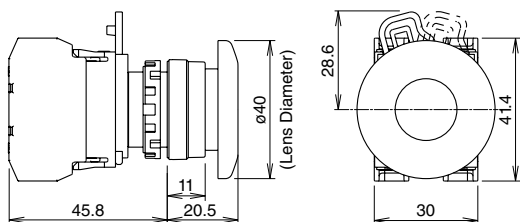

Extended with Full Shroud

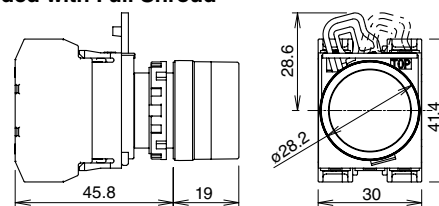



All dimensions in mm.

YW Series Illuminated Pushbuttons ø22

Illuminated Pushbuttons with Metal Bezel

Package Quantity: 1

Shape	Lamp	Operation	Contact	Contact Block Mounting Position			Part No.	③ Operating Voltage Code	② Lens Color Code				
				1	2	3							
	Without Lamp	Momentary	1NO	NO	FA	—	YW4L-M2E10Q0 ^②	0: without lamp 250V AC/DC max.	A: amber G: green R: red S: blue W: white Y: yellow				
			1NC	—	FA	NC	YW4L-M2E01Q0 ^②						
			2NO	NO	FA	NO	YW4L-M2E20Q0 ^②						
			2NC	NC	FA	NC	YW4L-M2E02Q0 ^②						
		1NO-1NC	NO	FA	NC	YW4L-M2E11Q0 ^②							
		Maintained	1NO	NO	FA	—	YW4L-A2E10Q0 ^②						
			1NC	—	FA	NC	YW4L-A2E01Q0 ^②						
			2NO	NO	FA	NO	YW4L-A2E20Q0 ^②						
			2NC	NC	FA	NC	YW4L-A2E02Q0 ^②						
		1NO-1NC	NO	FA	NC	YW4L-A2E11Q0 ^②							
		LED	Momentary	1NO	NO	FA	—			YW4L-M2E10Q ^{③②}	2: 6V AC/DC 3: 12V AC/DC 4: 24V AC/DC H: 110V AC/DC M3: 230/240V AC/DC	A: amber G: green PW: pure white R: red S: blue W: white Y: yellow Built-in LED lamp: LSED-③②	
				1NC	—	FA	NC			YW4L-M2E01Q ^{③②}			
	2NO			NO	FA	NO	YW4L-M2E20Q ^{③②}						
	2NC			NC	FA	NC	YW4L-M2E02Q ^{③②}						
	1NO-1NC		NO	FA	NC	YW4L-M2E11Q ^{③②}							
	Maintained		1NO	NO	FA	—	YW4L-A2E10Q ^{③②}						
			1NC	—	FA	NC	YW4L-A2E01Q ^{③②}						
			2NO	NO	FA	NO	YW4L-A2E20Q ^{③②}						
			2NC	NC	FA	NC	YW4L-A2E02Q ^{③②}						
	1NO-1NC		NO	FA	NC	YW4L-A2E11Q ^{③②}							
			Without Lamp	Momentary	1NO	NO	FA	—	YW4L-MF2E10Q0 ^②	0: without lamp 250V AC/DC max.			A: amber G: green R: red S: blue W: white Y: yellow
					1NC	—	FA	NC	YW4L-MF2E01Q0 ^②				
		2NO			NO	FA	NO	YW4L-MF2E20Q0 ^②					
		2NC			NC	FA	NC	YW4L-MF2E02Q0 ^②					
1NO-1NC		NO		FA	NC	YW4L-MF2E11Q0 ^②							
Maintained		1NO		NO	FA	—	YW4L-AF2E10Q0 ^②						
		1NC		—	FA	NC	YW4L-AF2E01Q0 ^②						
		2NO		NO	FA	NO	YW4L-AF2E20Q0 ^②						
		2NC		NC	FA	NC	YW4L-AF2E02Q0 ^②						
1NO-1NC		NO		FA	NC	YW4L-AF2E11Q0 ^②							
LED		Momentary		1NO	NO	FA	—	YW4L-MF2E10Q ^{③②}	2: 6V AC/DC 3: 12V AC/DC 4: 24V AC/DC H: 110V AC/DC M3: 230/240V AC/DC		A: amber G: green PW: pure white R: red S: blue W: white Y: yellow Built-in LED lamp: LSED-③②		
				1NC	—	FA	NC	YW4L-MF2E01Q ^{③②}					
			2NO	NO	FA	NO	YW4L-MF2E20Q ^{③②}						
			2NC	NC	FA	NC	YW4L-MF2E02Q ^{③②}						
		1NO-1NC	NO	FA	NC	YW4L-MF2E11Q ^{③②}							
		Maintained	1NO	NO	FA	—	YW4L-AF2E10Q ^{③②}						
			1NC	—	FA	NC	YW4L-AF2E01Q ^{③②}						
			2NO	NO	FA	NO	YW4L-AF2E20Q ^{③②}						
			2NC	NC	FA	NC	YW4L-AF2E02Q ^{③②}						
		1NO-1NC	NO	FA	NC	YW4L-AF2E11Q ^{③②}							
		Incandescent	Momentary	1NO	NO	FA	—	YW4L-MF2E10Q ^{③②}		5: 6V AC/DC 6: 12V AC/DC 7: 24V AC/DC		A: amber G: green R: red S: blue W: white Y: yellow Built-in incandescent lamp: LS-T ^③	
				1NC	—	FA	NC	YW4L-MF2E01Q ^{③②}					
2NO				NO	FA	NO	YW4L-MF2E20Q ^{③②}						
2NC				NC	FA	NC	YW4L-MF2E02Q ^{③②}						
1NO-1NC	NO		FA	NC	YW4L-MF2E11Q ^{③②}								
Maintained	1NO		NO	FA	—	YW4L-AF2E10Q ^{③②}							
	1NC		—	FA	NC	YW4L-AF2E01Q ^{③②}							
	2NO		NO	FA	NO	YW4L-AF2E20Q ^{③②}							
	2NC		NC	FA	NC	YW4L-AF2E02Q ^{③②}							
1NO-1NC	NO		FA	NC	YW4L-AF2E11Q ^{③②}								



Note: Specify a lens color code in place of ② in the Part No.
Specify an operating voltage code in place of ③ in the Part No.

FA: Full voltage adapter

ø22 YW Series Illuminated Pushbuttons

Style	Lamp	Operation	Contact	Contact Block Mounting Position			Part No.	③ Operating Voltage Code	② Lens Color Code			
				1	2	3						
	Without Lamp	Momentary	1NO	NO	FA	—	YW4L-M4E10Q0 ②	0: without lamp 250V AC/DC max.	A: amber G: green R: red S: blue W: white Y: yellow			
			1NC	—	FA	NC	YW4L-M4E01Q0 ②					
			2NO	NO	FA	NO	YW4L-M4E20Q0 ②					
			2NC	NC	FA	NC	YW4L-M4E02Q0 ②					
		Maintained	1NO-1NC	NO	FA	NC	YW4L-M4E11Q0 ②					
			1NO	NO	FA	—	YW4L-A4E10Q0 ②					
			1NC	—	FA	NC	YW4L-A4E01Q0 ②					
			2NO	NO	FA	NO	YW4L-A4E20Q0 ②					
		LED	Momentary	2NC	NC	FA	NC			YW4L-A4E02Q0 ②	2: 6V AC/DC 3: 12V AC/DC 4: 24V AC/DC H: 110V AC/DC M3: 230/240V AC/DC	A: amber G: green PW: pure white R: red S: blue W: white Y: yellow Built-in LED lamp: LSED-③②
				1NO-1NC	NO	FA	NC			YW4L-M4E11Q ③②		
				1NO	NO	FA	—			YW4L-M4E10Q ③②		
				1NC	—	FA	NC			YW4L-M4E01Q ③②		
	Maintained		2NO	NO	FA	NO	YW4L-M4E20Q ③②					
			2NC	NC	FA	NC	YW4L-M4E02Q ③②					
			1NO-1NC	NO	FA	NC	YW4L-M4E11Q ③②					
			1NO	NO	FA	—	YW4L-A4E10Q ③②					
	Incandescent		Momentary	1NC	—	FA	NC	YW4L-A4E01Q ③②	5: 6V AC/DC 6: 12V AC/DC 7: 24V AC/DC	A: amber G: green R: red S: blue W: white Y: yellow Built-in incandescent lamp: LS-T③		
				2NO	NO	FA	NO	YW4L-A4E20Q ③②				
				2NC	NC	FA	NC	YW4L-A4E02Q ③②				
				1NO-1NC	NO	FA	NC	YW4L-M4E11Q ③②				
		Maintained	1NO	NO	FA	—	YW4L-M4E10Q ③②					
			1NC	—	FA	NC	YW4L-M4E01Q ③②					
			2NO	NO	FA	NO	YW4L-M4E20Q ③②					
			2NC	NC	FA	NC	YW4L-M4E02Q ③②					
				1NO-1NC	NO	FA	NC	YW4L-A4E11Q ③②				

Note: Specify a lens color code in place of ② in the Part No.
Specify an operating voltage code in place of ③ in the Part No.

FA: Full voltage adapter

Dimensions (Illuminated Pushbutton with Metal Bezel)

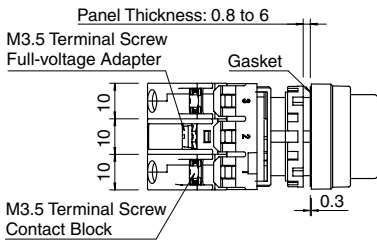

Contact Block Mounting Position



Extended

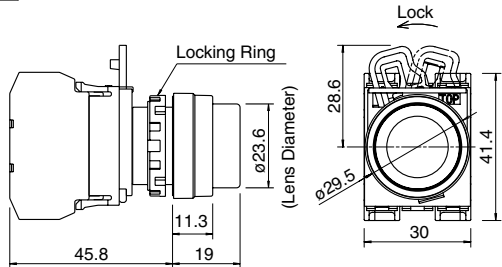

Mushroom

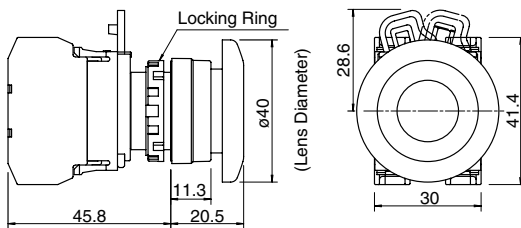

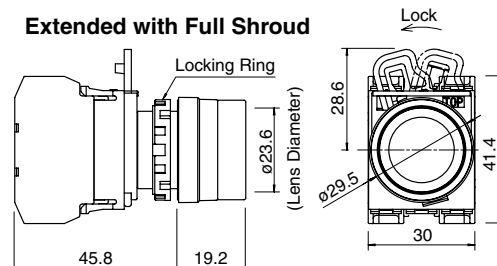

Extended with Full Shroud



All dimensions in mm.

Selector Switches with Plastic Bezel



Package Quantity: 1

Shape				Knob									
				Operator Position			Maintained	Spring Return from Right					—
No. of Positions	Contact Configuration	Contact Block Mounting Position		L	R	—							
90° 2-Position 	1NO (10)	1	NO		●		YW1S-2E10	YW1S-21E10	—	—			
		2											
		3											
	1NC (01)	1			●			YW1S-2E01	YW1S-21E01	—	—		
		2											
		3	NC	●									
	2NO (20)	1	NO			●		YW1S-2E20	YW1S-21E20	—	—		
		2											
		3	NO			●							
	2NC (02)	1	NC	●				YW1S-2E02	YW1S-21E02	—	—		
		2											
		3	NC	●									
	1NO-1NC (11)	1	NO			●		YW1S-2E11	YW1S-21E11	—	—		
		2											
		3	NC	●									
	3NO (30)	1	NO			●		YW1S-2E30	YW1S-21E30	—	—		
		2	NO			●							
		3	NO			●							
3NC (03)	1	NC	●				YW1S-2E03	YW1S-21E03	—	—			
	2	NC	●										
	3	NC	●										
2NO-1NC (21)	1	NO			●		YW1S-2E21	YW1S-21E21	—	—			
	2	NC	●										
	3	NO			●								
1NO-2NC (12)	1	NO			●		YW1S-2E12	YW1S-21E12	—	—			
	2	NC	●										
	3	NC	●										
45° 3-Position 	2NO (20)	1	NO	●			YW1S-3E20	YW1S-31E20	YW1S-32E20	YW1S-33E20			
		2											
		3	NO			●							
	2NO (20N1)	1	NO	●			●	YW1S-3E20N1	YW1S-31E20N1	YW1S-32E20N1	YW1S-33E20N1		
		2	NO				●						
		3	NO				●						
	2NC (02)	1	NC				■	YW1S-3E02	YW1S-31E02	YW1S-32E02	YW1S-33E02		
		2					■						
		3	NC	■									
	2NC (02N1)	1	NC				■	YW1S-3E02N1	YW1S-31E02N1	YW1S-32E02N1	YW1S-33E02N1		
		2	NC				■						
		3	NC	■									
	1NO-1NC (11)	1	NO	●				YW1S-3E11	YW1S-31E11	YW1S-32E11	YW1S-33E11		
		2					■						
		3	NC	■									
	1NO-1NC (11N1)	1	NC				■	YW1S-3E11N1	YW1S-31E11N1	YW1S-32E11N1	YW1S-33E11N1		
		2					■						
		3	NO			●							
	1NO-1NC (11N2)	1	NO	●				YW1S-3E11N2	YW1S-31E11N2	YW1S-32E11N2	YW1S-33E11N2		
		2	NC			●							
		3											
1NO-1NC (11N3)	1						YW1S-3E11N3	YW1S-31E11N3	YW1S-32E11N3	YW1S-33E11N3			
	2	NC			●								
	3	NO				●							
1NO-1NC (11N4)	1						YW1S-3E11N4	YW1S-31E11N4	YW1S-32E11N4	YW1S-33E11N4			
	2	NO	●			●							
	3	NC	■										
3NO (30)	1	NO	●				YW1S-3E30	YW1S-31E30	YW1S-32E30	YW1S-33E30			
	2	NO	●			●							
	3	NO				●							
3NC (03)	1	NC				■	YW1S-3E03	YW1S-31E03	YW1S-32E03	YW1S-33E03			
	2	NC				■							
	3	NC	■										
2NO-1NC (21)	1	NO	●				YW1S-3E21	YW1S-31E21	YW1S-32E21	YW1S-33E21			
	2	NC			●								
	3	NO				●							
1NO-2NC (12)	1	NC				■	YW1S-3E12	YW1S-31E12	YW1S-32E12	YW1S-33E12			
	2	NO	●			●							
	3	NC	■										

ø22 YW Series Selector Switches

Selector Switches with Metal Bezel

Package Quantity: 1

Shape	Knob  
-------	---

No. of Positions	Contact Configuration	Contact Block Mounting Position		Operator Position			Maintained	Spring Return from Right	—	—	
				L	R	—					
90° 2-Position 	1NO (10)	1	NO		●		YW4S-2E10	YW4S-21E10	—	—	
		2									
		3									
	1NC (01)	1			●			YW4S-2E01	YW4S-21E01	—	—
		2									
		3	NC	●							
	2NO (20)	1	NO			●		YW4S-2E20	YW4S-21E20	—	—
		2									
		3	NO			●					
	2NC (02)	1	NC	●				YW4S-2E02	YW4S-21E02	—	—
		2									
		3	NC	●							
	1NO-1NC (11)	1	NO			●		YW4S-2E11	YW4S-21E11	—	—
		2									
		3	NC	●							
	3NO (30)	1	NO			●		YW4S-2E30	YW4S-21E30	—	—
		2	NO			●					
		3	NO			●					
3NC (03)	1	NC	●				YW4S-2E03	YW4S-21E03	—	—	
	2	NC	●								
	3	NC	●								
2NO-1NC (21)	1	NO			●		YW4S-2E21	YW4S-21E21	—	—	
	2	NC	●								
	3	NO			●						
1NO-2NC (12)	1	NO			●		YW4S-2E12	YW4S-21E12	—	—	
	2	NC	●								
	3	NC	●								

No. of Positions	Contact Configuration	Contact Block Mounting Position		Operator Position			Maintained	Spring Return from Right	Spring Return from Left	Spring Return Two-Way	
				L	C	R					
45° 3-Position 	2NO (20)	1	NO	●			YW4S-3E20	YW4S-31E20	YW4S-32E20	YW4S-33E20	
		2									
		3	NO			●					
	2NO (20N1)	1			●		●	YW4S-3E20N1	YW4S-31E20N1	YW4S-32E20N1	YW4S-33E20N1
		2	NO			●					
		3	NO			●					
	2NC (02)	1	NC					YW4S-3E02	YW4S-31E02	YW4S-32E02	YW4S-33E02
		2									
		3	NC								
	2NC (02N1)	1				●		YW4S-3E02N1	YW4S-31E02N1	YW4S-32E02N1	YW4S-33E02N1
		2	NC								
		3	NC								
	1NO-1NC (11)	1	NO			●		YW4S-3E11	YW4S-31E11	YW4S-32E11	YW4S-33E11
		2									
		3	NC								
	1NO-1NC (11N1)	1	NC					YW4S-3E11N1	YW4S-31E11N1	YW4S-32E11N1	YW4S-33E11N1
		2									
		3	NO			●					
	1NO-1NC (11N2)	1	NO			●		YW4S-3E11N2	YW4S-31E11N2	YW4S-32E11N2	YW4S-33E11N2
		2	NC			●					
		3									
	1NO-1NC (11N3)	1						YW4S-3E11N3	YW4S-31E11N3	YW4S-32E11N3	YW4S-33E11N3
		2	NC			●					
		3	NO			●					
1NO-1NC (11N4)	1						YW4S-3E11N4	YW4S-31E11N4	YW4S-32E11N4	YW4S-33E11N4	
	2	NO			●						
	3	NC			●						
3NO (30)	1	NO			●		YW4S-3E30	YW4S-31E30	YW4S-32E30	YW4S-33E30	
	2	NO			●						
	3	NO			●						
3NC (03)	1	NC					YW4S-3E03	YW4S-31E03	YW4S-32E03	YW4S-33E03	
	2	NC									
	3	NC									
2NO-1NC (21)	1	NO			●		YW4S-3E21	YW4S-31E21	YW4S-32E21	YW4S-33E21	
	2	NC			●						
	3	NO			●						
1NO-2NC (12)	1	NC					YW4S-3E12	YW4S-31E12	YW4S-32E12	YW4S-33E12	
	2	NO			●						
	3	NC			●						

Contact Block Mounting Position

Selector Switch with Plastic Bezel



Dimensions

Selector Switch with Plastic Bezel

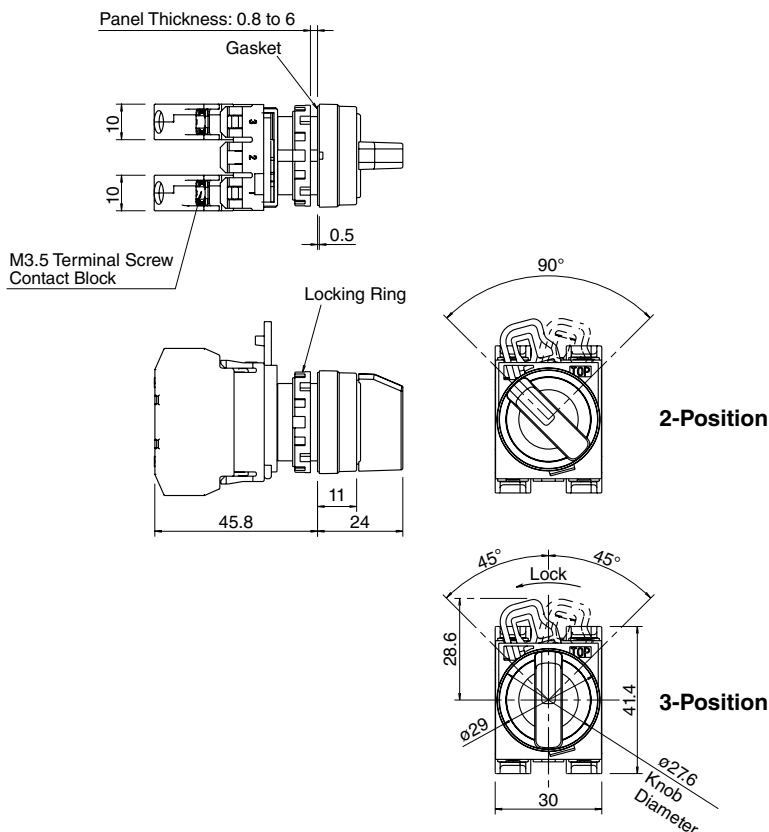

Selector Switch with Metal Bezel



Selector Switch with Metal Bezel

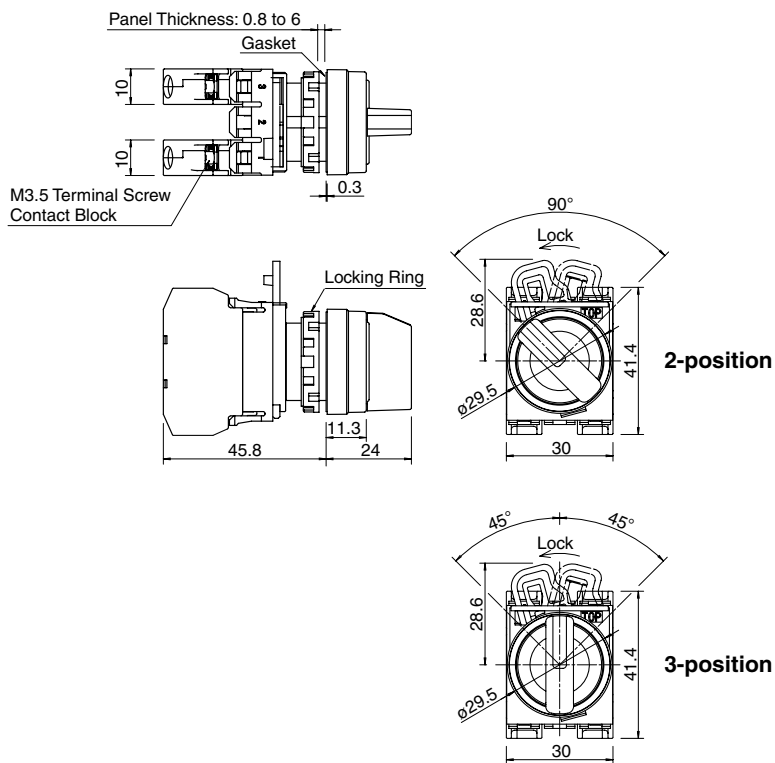





All dimensions in mm.

ø22 YW Series Key Selector Switches

Key Selector Switches (90° 2-Position)



Package Quantity: 1

No. of Positions	Contact Configuration	Contact Block Mounting Position		Operator Position		Part No.		
				L	R	Plastic Bezel	Metal Bezel	
								
90° 2-position Maintained 	1NO (10)	1	NO		●	YW1K-2AE10	YW4K-2AE10	
		2						
		3						
	1NC (01)	1					YW1K-2AE01	YW4K-2AE01
		2						
		3	NC	●				
	2NO (20)	1	NO			●	YW1K-2AE20	YW4K-2AE20
		2						
		3	NO			●		
	2NC (02)	1	NC	●			YW1K-2AE02	YW4K-2AE02
		2						
		3	NC	●				
	1NO-1NC (11)	1	NO			●	YW1K-2AE11	YW4K-2AE11
		2						
		3	NC	●				
	3NO (30)	1	NO			●	YW1K-2AE30	YW4K-2AE30
		2	NO			●		
		3	NO			●		
3NC (03)	1	NC	●			YW1K-2AE03	YW4K-2AE03	
	2	NC	●					
	3	NC	●					
2NO-1NC (21)	1	NO			●	YW1K-2AE21	YW4K-2AE21	
	2	NC	●					
	3	NO			●			
1NO-2NC (12)	1	NO			●	YW1K-2AE12	YW4K-2AE12	
	2	NC	●					
	3	NC	●					
90° 2-position Spring Return from Right 	1NO (10)	1	NO		●	YW1K-21BE10	YW4K-21BE10	
		2						
		3						
	1NC (01)	1					YW1K-21BE01	YW4K-21BE01
		2						
		3	NC	●				
	2NO (20)	1	NO			●	YW1K-21BE20	YW4K-21BE20
		2						
		3	NO			●		
	2NC (02)	1	NC	●			YW1K-21BE02	YW4K-21BE02
		2						
		3	NC	●				
	1NO-1NC (11)	1	NO			●	YW1K-21BE11	YW4K-21BE11
		2						
		3	NC	●				
	3NO (30)	1	NO			●	YW1K-21BE30	YW4K-21BE30
		2	NO			●		
		3	NO			●		
3NC (03)	1	NC	●			YW1K-21BE03	YW4K-21BE03	
	2	NC	●					
	3	NC	●					
2NO-1NC (21)	1	NO			●	YW1K-21BE21	YW4K-21BE21	
	2	NC	●					
	3	NO			●			
1NO-2NC (12)	1	NO			●	YW1K-21BE12	YW4K-21BE12	
	2	NC	●					
	3	NC	●					

- On the spring-returned types, the key can be removed only from the maintained position. On the maintained types, the key can be removed from every position. Key retained positions are also available. See Part No. Development shown on page 21.
- Each key selector switch is supplied with two identical keys.

Key Selector Switches (45° 3-Position)

Package Quantity: 1

No. of Positions	Contact Configuration	Contact Block Mounting Position		Operator Position			Part No.		
				L	C	R	Plastic Bezel	Metal Bezel	
									
45° 3-position Maintained 	2NO (20)	1	NO	●			YW1K-3AE20	YW4K-3AE20	
		2							
		3	NO			●			
	2NO (20N1)	1						YW1K-3AE20N1	YW4K-3AE20N1
		2	NO	●			●		
		3	NO				●		
	2NC (02)	1	NC		▬			YW1K-3AE02	YW4K-3AE02
		2							
		3	NC	▬					
	2NC (02N1)	1						YW1K-3AE02N1	YW4K-3AE02N1
		2	NC		●				
		3	NC	▬					
	1NO-1NC (11)	1	NO	●				YW1K-3AE11	YW4K-3AE11
		2							
		3	NC	▬					
	1NO-1NC (11N1)	1	NC			▬		YW1K-3AE11N1	YW4K-3AE11N1
		2							
		3	NO				●		
	1NO-1NC (11N2)	1	NO	●				YW1K-3AE11N2	YW4K-3AE11N2
		2	NC			●			
3									
1NO-1NC (11N3)	1						YW1K-3AE11N3	YW4K-3AE11N3	
	2	NC			●				
	3	NO				●			
1NO-1NC (11N4)	1						YW1K-3AE11N4	YW4K-3AE11N4	
	2	NO	●			●			
	3	NC	▬						
3NO (30)	1	NO	●				YW1K-3AE30	YW4K-3AE30	
	2	NO	●			●			
	3	NO				●			
3NC (03)	1	NC		▬			YW1K-3AE03	YW4K-3AE03	
	2	NC			●				
	3	NC	▬						
2NO-1NC (21)	1	NO	●				YW1K-3AE21	YW4K-3AE21	
	2	NC			●				
	3	NO				●			
1NO-2NC (12)	1	NC			▬		YW1K-3AE12	YW4K-3AE12	
	2	NO	●			●			
	3	NC	▬						

- On the maintained types, the key can be removed from every position. Key retained positions are also available. See Part No. Development below.
- Each key selector switch is supplied with two identical keys.

Part No. Development

YW1K-2 A E21

 Key removal position code
 2-position

- A: Removable in all positions
- B: Removable in left only
- C: Removable in right only

3-position

- A: Removable in all positions
- B: Removable in left and center
- C: Removable in right and center
- D: Removable in center only
- E: Removable in right and left
- G: Removable in left only
- H: Removable in right only

Contact Block Mounting Position

Contact Block Mounting Position

1 2 3





L C R

Operator Position

ø22 YW Series Key Selector Switches

Key Selector Switches (45° 3-Position)













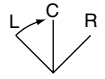















Package Quantity: 1

No. of Positions	Contact Configuration	Contact Block Mounting Position		Operator Position			Part No.		
				L	C	R	Plastic Bezel	Metal Bezel	
45° 3-position Spring Return from Right 	2NO (20)	1	NO	●			 cUL LISTED CE CCC	 cUL LISTED CE CCC	
		2							
		3	NO			●			
	2NO (20N1)	1						YW1K-31BE20N1	YW4K-31BE20N1
		2	NO	●			●		
		3	NO				●		
	2NC (02)	1	NC			■		YW1K-31BE02	YW4K-31BE02
		2							
		3	NC	■					
	2NC (02N1)	1						YW1K-31BE02N1	YW4K-31BE02N1
		2	NC		●				
		3	NC	■					
	1NO-1NC (11)	1	NO	●				YW1K-31BE11	YW4K-31BE11
		2							
		3	NC	■					
	1NO-1NC (11N1)	1	NC			■		YW1K-31BE11N1	YW4K-31BE11N1
		2							
		3	NO			●			
	1NO-1NC (11N2)	1	NO	●				YW1K-31BE11N2	YW4K-31BE11N2
		2	NC		●				
3									
1NO-1NC (11N3)	1						YW1K-31BE11N3	YW4K-31BE11N3	
	2	NC		●					
	3	NO			●				
1NO-1NC (11N4)	1						YW1K-31BE11N4	YW4K-31BE11N4	
	2	NO	●		●				
	3	NC	■						
3NO (30)	1	NO	●				YW1K-31BE30	YW4K-31BE30	
	2	NO	●		●				
	3	NO			●				
3NC (03)	1	NC			■		YW1K-31BE03	YW4K-31BE03	
	2	NC		●					
	3	NC	■						
2NO-1NC (21)	1	NO	●				YW1K-31BE21	YW4K-31BE21	
	2	NC		●					
	3	NO			●				
1NO-2NC (12)	1	NC			■		YW1K-31BE12	YW4K-31BE12	
	2	NO	●		●				
	3	NC	■						

- On the spring-returned types, the key can be removed only from the maintained position. Key retained positions are also available. See Part No. Development shown on page 21.
- Each key selector switch is supplied with two identical keys.

Key Selector Switches (45° 3-Position)

Package Quantity: 1





No. of Positions	Contact Configuration	Contact Block Mounting Position		Operator Position			Part No.		
				L	C	R	Plastic Bezel	Metal Bezel	
									
45° 3-position Spring Return from Left 	2NO (20)	1	NO	●					
		2							
		3	NO			●			
	2NO (20N1)	1							
		2	NO	●		●			
		3	NO			●			
	2NC (02)	1	NC		▬				
		2							
		3	NC	▬					
	2NC (02N1)	1							
		2	NC		●				
		3	NC	▬					
	1NO-1NC (11)	1	NO	●					
		2							
		3	NC	▬					
	1NO-1NC (11N1)	1	NC			▬			
		2					●		
		3	NO				●		
	1NO-1NC (11N2)	1	NO	●					
		2	NC			●			
		3							
	1NO-1NC (11N3)	1							
		2	NC			●			
		3	NO				●		
1NO-1NC (11N4)	1								
	2	NO	●			●			
	3	NC	▬						
3NO (30)	1	NO	●						
	2	NO	●			●			
	3	NO				●			
3NC (03)	1	NC		▬					
	2	NC			●				
	3	NC	▬						
2NO-1NC (21)	1	NO	●						
	2	NC			●				
	3	NO				●			
1NO-2NC (12)	1	NC		▬					
	2	NO	●			●			
	3	NC	▬						

- On the spring-returned types, the key can be removed only from the maintained position. Key retained positions are also available. See Part No. Development shown on page 21.
- Each key selector switch is supplied with two identical keys.

ø22 YW Series Key Selector Switches

Key Selector Switches (45° 3-Position)

Package Quantity: 1

No. of Positions	Contact Configuration	Contact Block Mounting Position		Operator Position			Part No.		
				L	C	R	Plastic Bezel	Metal Bezel	
									
45° 3-position Spring Return Two-way 	2NO (20)	1	NO	●					
		2							
		3	NO			●			
	2NO (20N1)	1						YW1K-33DE20N1	YW4K-33DE20N1
		2	NO	●		●			
		3	NO			●			
	2NC (02)	1	NC			■		YW1K-33DE02	YW4K-33DE02
		2							
		3	NC	■					
	2NC (02N1)	1						YW1K-33DE02N1	YW4K-33DE02N1
		2	NC		●				
		3	NC	■					
	1NO-1NC (11)	1	NO	●				YW1K-33DE11	YW4K-33DE11
		2							
		3	NC	■					
	1NO-1NC (11N1)	1	NC			■		YW1K-33DE11N1	YW4K-33DE11N1
		2							
		3	NO			●			
	1NO-1NC (11N2)	1	NO	●				YW1K-33DE11N2	YW4K-33DE11N2
		2	NC		●				
3									
1NO-1NC (11N3)	1						YW1K-33DE11N3	YW4K-33DE11N3	
	2	NC		●					
	3	NO			●				
1NO-1NC (11N4)	1						YW1K-33DE11N4	YW4K-33DE11N4	
	2	NO	●		●				
	3	NC	■						
3NO (30)	1	NO	●				YW1K-33DE30	YW4K-33DE30	
	2	NO	●		●				
	3	NO			●				
3NC (03)	1	NC			■		YW1K-33DE03	YW4K-33DE03	
	2	NC		●					
	3	NC	■						
2NO-1NC (21)	1	NO	●				YW1K-33DE21	YW4K-33DE21	
	2	NC		●					
	3	NO			●				
1NO-2NC (12)	1	NC			■		YW1K-33DE12	YW4K-33DE12	
	2	NO	●		●				
	3	NC	■						

- On the spring-returned types, the key can be removed only from the maintained position. Key retained positions are also available. See Part No. Development shown on page 21.
- Each key selector switch is supplied with two identical keys.

Dimensions (Key Selector Switch)

Plastic Bezel

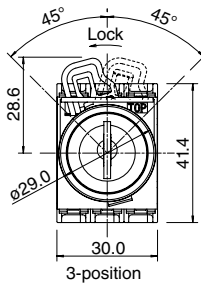
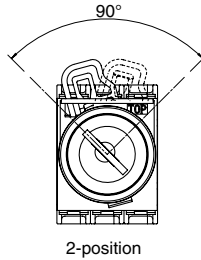
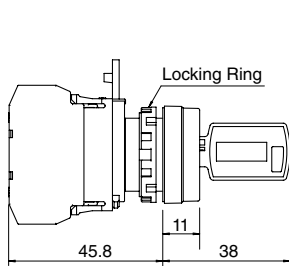
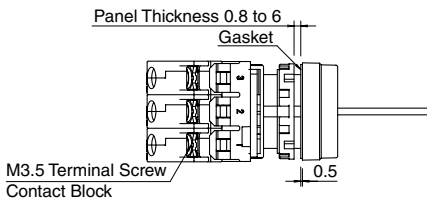

Metal Bezel

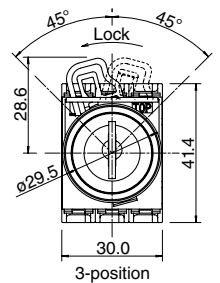
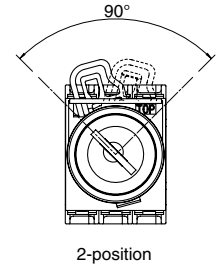
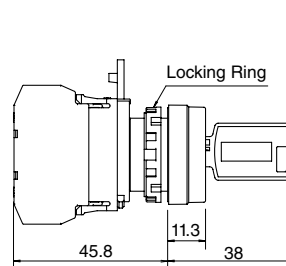
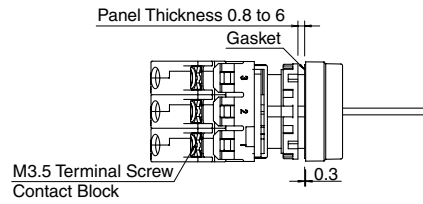

All dimensions in mm.

Emergency Stop Switches

Pushbuttons







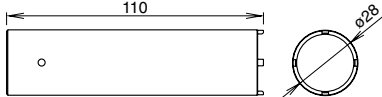

Pilot Lights

Illuminated Pushbuttons

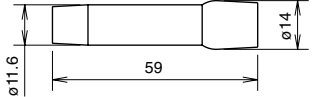
Selector Switches

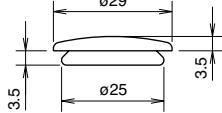
Key Selector Switches

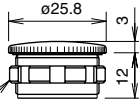

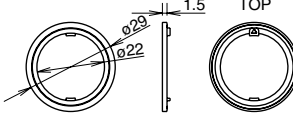



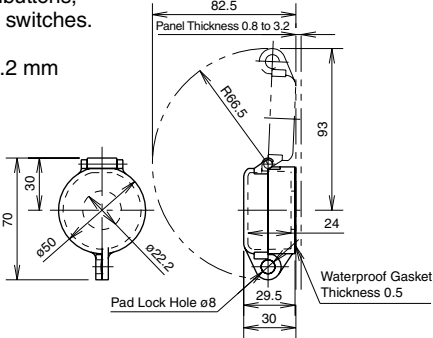

Accessories

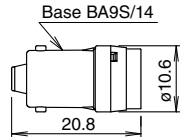
Name & Shape	Part No.	Description & Dimensions (mm)	Package Quantity
	MW9Z-T1	Metallic tool used to tighten the plastic locking ring when installing the YW series in a panel. 	1
	OR-55	Made of rubber. Used for replacing lamps. 	1
	OB-31PN05	Used for plugging unused mounting holes in the panel. Color: Black 	5
	LW9Z-BM	Used for plugging unused mounting holes in the panel. Weight: Approx. 18g 	1
	HW9Z-RLPN10	Prevents rotation of switches in panel. Mainly used with selector switches when no nameplate is used. With waterproof gasket (IP65). Made of plastic (black). Applicable panel thickness: 1.2 to 4.5 mm 	10

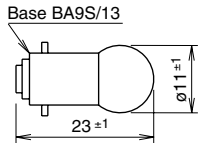
ø22 YW Series Accessories / Maintenance Parts

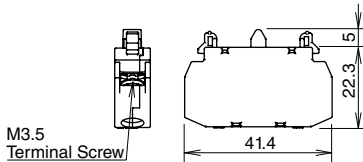
Name & Shape	Part No.	Description & Dimensions (mm)	Package Quantity
	HW9Z-KL1	Plastic hinged cover to protect pushbuttons, illuminated pushbuttons, or selector switches. Degree of protection: IP65. Applicable panel thickness: 0.8 to 3.2 mm 	1

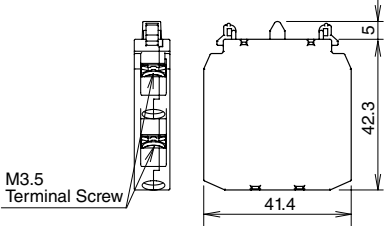
Maintenance Parts

Name & Shape	Part No.	Description & Dimensions (mm)		Package Quantity	
	LSED-6②	6V AC/DC	Specify a color code in place of ② in the Part No.: A (amber), G (green), PW (pure white), R (red), S (blue), Y (yellow) See page 4 for applicable units and rated current. Note: Yellow LED lamps are used for white illumination of pilot lights and illuminated pushbuttons.		1
	LSED-1②	12V AC/DC			
	LSED-2②	24V AC/DC			
	LSED-H②	110V/120V AC/DC			
	LSED-M3②	230/240V AC/DC			
	LS-T6P	6.3V, 1W	One pack contains 100 incandescent lamps.		100
	LS-T8P	18V, 1W			
	LS-T3P	30V, 1W			
	YW-E10	Contact: 1NO	Color: blue		10
	YW-E01	Contact: 1NC	Color: reddish purple		
	YW-EW20	Contact: 2NO	Color: blue		10
	YW-EW02	Contact: 2NC	Color: reddish purple		
	YW-EW11	Contact: 1NO-1NC	Color: blue and reddish purple		
	YW9Z-SK00PN02				2

Buttons, Lenses, and Marking Plates

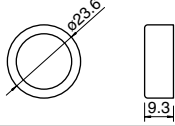
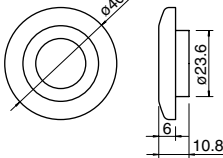
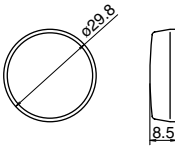
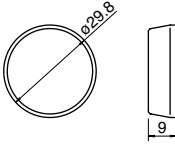
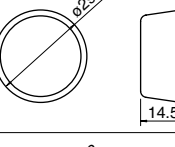
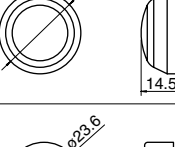
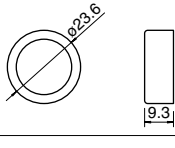
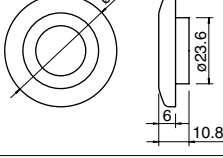
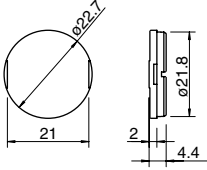
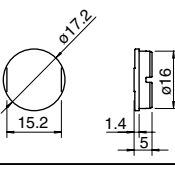
Name	Style	Part No.	① ② Color Code	Dimensions (mm)	Package Quantity
Button (for pushbuttons)	Extended	YW9Z-B12①PN10	B: black G: green R: red S: blue W: white Y: yellow		10
	Mushroom ø40mm	YW9Z-B14①PN10			
Lens (for pilot lights)	Flush	YW9Z-PL11②PN10	A: amber C: clear G: green R: red S: blue W: white Y: yellow		10
	Flush Marking	YW9Z-PL11B②PN10	A: amber C: clear G: green R: red S: blue Y: yellow		10
	Extended	YW9Z-PL12T②PN10	A: amber C: clear G: green R: red S: blue W: white Y: yellow		10
	Dome	YW9Z-PL12②PN10	A: amber C: clear G: green R: red S: blue Y: yellow		10
Lens (for illuminated pushbuttons)	Extended	YW9Z-L12②PN10	A: amber C: clear G: green R: red S: blue Y: yellow		10
	Mushroom ø40mm	YW9Z-L14②PN10			
Marking Plate (for pilot lights)	—	YW9Z-PP12PN10	—		10
Marking Plate (for illuminated pushbuttons)	—	YW9Z-P12PN10	—		10

Nameplates

HWAM, HWAQ, HWAS, and HWAV

Name	Legend	Material	Part No.	Ordering No.	Package Quantity	Dimensions (mm)
HWAM	Order marking plate separately.	Plastic (black) 1.5 mm thick	HWAM	HWAM	1	
				HWAMPN10	10	
HWAQ	Order marking plate separately.	Plastic (black) 1.5 mm thick	HWAQ	HWAQ	1	
				HWAQPN10	10	
HWAQ	Blank	Plastic (black) 1.5 mm thick	HWAS-0	HWAS-0	1	
				HWAS-0PN10	10	
HWAV	Blank	Plastic (yellow) 1.5 mm thick	HWAV-0	HWAV-0	1	
	EMERGENCY STOP		HWAV-27	HWAV-27	1	

• Legend "Emergency Stop" is indicated outside a ø44mm circle.

Making Plate

Description	Material	Part No.	Ordering No.	Package Quantity	Dimensions (mm)
HWNP	Aluminum (black) 1.0 mm thick	HWNP-*	HWNP-*	1	
			HWNP-*PN10	10	

• White legend on black background.

• Specify a legend code in place of * in the Ordering No.

Legends

Code	Legend
0	(blank)
1	ON
2	OFF
3	START
4	STOP
31	OFF-ON
35	HAND-AUTO
53	HAND-OFF-AUTO

• Installing the marking plate on a nameplate

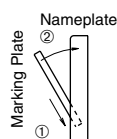



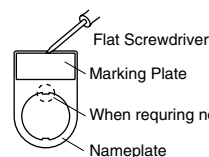





• To remove the marking plate, insert the flat screwdriver between the marking plate and nameplate.

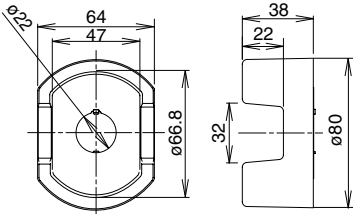

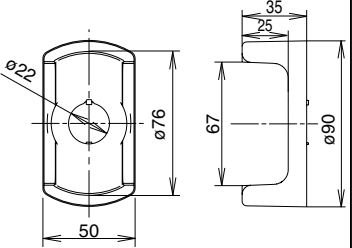
Note: When using an nameplate, the mounting panel thickness is decreased by 1.5 mm.

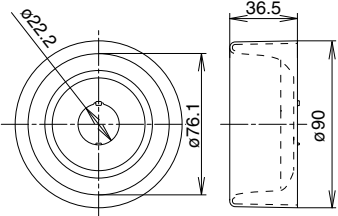
Switch Guards

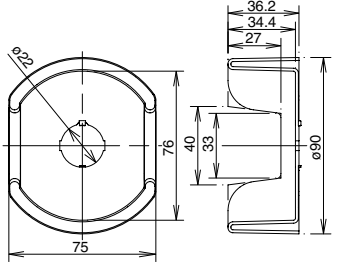
Package Quantity: 1

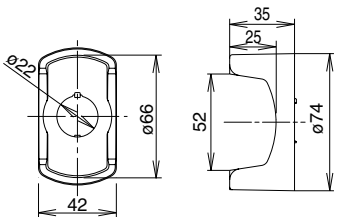
Part No. & Shape (mm)	Dimensions	Part No. & Shape	Dimensions (mm)
HW9Z-KG1  EMO Switch Guard SEMI S2 compliant (Note 1)		HW9Z-KG4  EMO Switch Guard SEMI S2 compliant (Note 2) SEMATECH compliant (Note 3)	
HW9Z-KG2  EMO Switch Guard SEMI S2 compliant (Note 1) SEMATECH compliant (Note 3)		HW9Z-KG5  EMO Switch Guard SEMI S2 compliant (Note 2) SEMATECH compliant (Note 3)	
HW9Z-KG3  EMO Switch Guard SEMI S2 compliant (Note 2)			

Material: Polyamide (PA6)
 Color: Yellow, Munsell 2.5Y 8/10 equivalent
 Degree of protection: IP65

• Degree of protection IP65 applies to the combination of an emergency stop switch and an EMO switch guard.

Note 1: SEMI S2-0703 12.5.1 compliant.

Note 2: The combination of IDEC's emergency stop switches and EMO switch guards are approved by TÜV Rheinland for compliance with SEMI S2 standard.

Note 3: SEMATECH Application Guide for SEMI S2-93, 12.4.c. compliant.

Transformer

Din Rail Mount Transformer For 6V

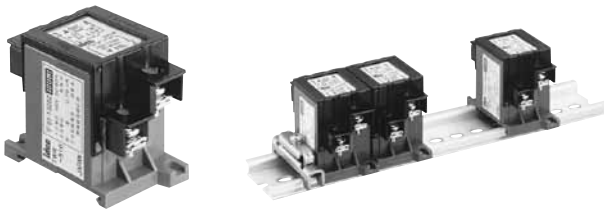

Primary Voltage (50/60 Hz)	Part No.	Applicable Lamp Rating
110V AC	TWR516	One full voltage type illuminated unit containing LED lamp LSED-6 (6V AC/DC) or incandescent lamp LS-T6 (6.3V)
115V AC	TWR5116	
120V AC	TWR5126	
220V AC	TWR526	
230V AC	TWR5236	
240V AC	TWR5246	
380V AC	TWR5386	
440V AC	TWR546	
480V AC	TWR5486	

Dimensions (mm)

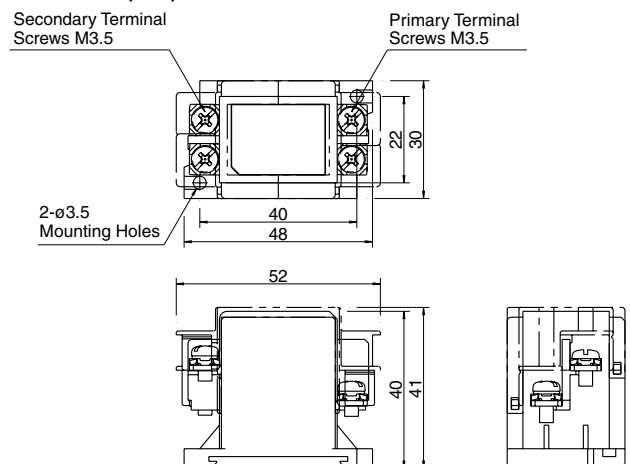

Note: Finger-safe terminal cover is supplied with the transformer.

Safety Precautions

- Turn off the power to the YW series before starting installation, removal, wiring, maintenance, and inspection of the products. Failure to turn power off may cause electrical shocks or fire hazard.
- To avoid burning your hand, use the lamp holder tool when replacing lamps.
- For wiring, use wires of a proper size to meet the voltage and

current requirements. Tighten the M3.5 terminal screws to a tightening torque of 1.0 N-m. Failure to tighten the terminal screws may cause overheating and fire.

Instructions

Panel Mounting

- Remove the contact block from the operator (for pilot lights, remove the transformer or full voltage unit from the pilot light). Remove the locking ring from the operator. Insert the operator into the panel cut-out from the front, tighten the locking ring from the back, then install the contact block to the operator.

Removing and Installing the Contact Block

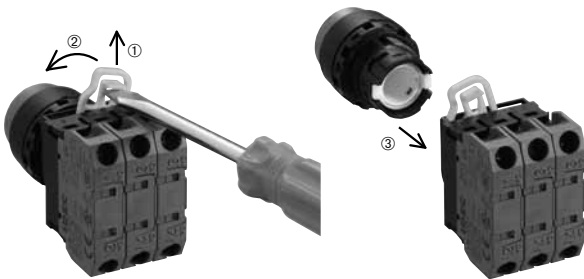

- ① Pull up the locking lever.
② Turn the lever to the left.

- ③ Pull out the contact block

1. To remove the operator from the contact block, pull up the locking lever and turn it to the left. Then the operator can be pulled out.
2. To reinstall, place the TOP marking on the operator and the TOP marking on the contact block mounting adapter in the same direction, and insert the operator into the contact block mounting adapter. Then turn the locking lever to the right.

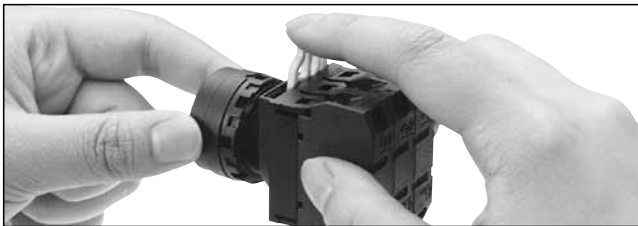

Removing and Installing the Transformer

1. Insert a flat screwdriver (5 mm wide at maximum) into the latch hole on the transformer unit as shown in the photo below, and disengage the latch. Then pull out the operator.
2. To reinstall, place the TOP marking on the operator and the latch in the same direction, and push the operator into the transformer.

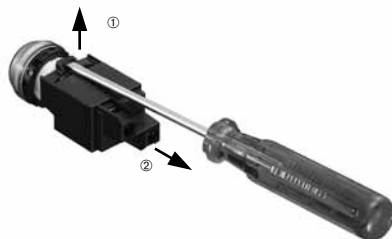

Removing the Full Voltage Unit

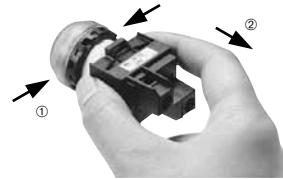

1. To remove the full voltage unit, squeeze the full voltage unit from both sides to disengage the latch as shown, and pull it out. Like the transformer unit, the full voltage unit can also be pulled out by inserting a flat screwdriver into the latch hole as shown.
2. To reinstall, place the TOP markings on the operator and the latch on the full voltage unit in the same direction, and insert the operator into the full voltage unit.

Notes for Panel Mounting

1. Use the optional locking wrench (MW9Z-T1) to mount the operator onto a panel. Tightening torque must not exceed 2.0 N-m. Do not use pliers. Excessive tightening will damage the locking ring.
2. For contact blocks and transformers housing LED and incandescent lamps, make sure not to press the lamps too hard, otherwise the lamp socket may be damaged.

Insertion Order of Lens and Marking Plate

Illuminated Pushbutton

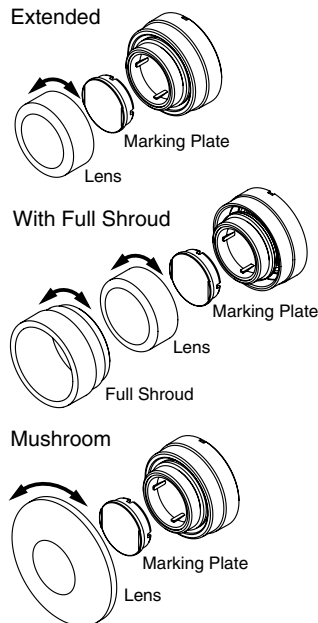

Pilot Light

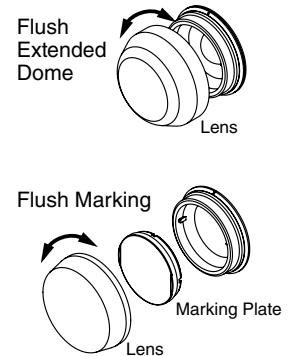

Marking

For YW series pilot lights and illuminated pushbuttons, legends and symbols can be engraved on built-in marking plates, or printed mylar film can be inserted under the lens for labeling purposes. Mylar film is not supplied with the YW series and must be supplied by the end user.

Built-in Marking Plate and Marking Film Size

Unit	Pilot Light	Illuminated Pushbutton
Built-in Marking Plate		
	Engraving depth: 0.5 mm maximum Marking plate material: White acrylic	
Applicable Marking Film		
	0.1-mm-thick x 2 sheets or 0.2-mm-thick x 1 sheet Film material: Mylar (recommended) Note: Marking film is not supplied with the pilot light or illuminated pushbutton.	

Replacement (LED and incandescent lamps)

Lamps can be replaced using the lamp holder tool (OR-55) from the front of the panel, or by removing the contact block from the operator unit.

Removing the Lamp from the Front of the Panel



To remove, gently insert the lamp holder tool onto the lamp head. Then push slightly, and turn the lamp holder tool to the left.

Installing the Lamp from the Front of the Panel

- To install, insert the lamp head into the lamp holder tool, and hold the lamp as shown in the figure below.

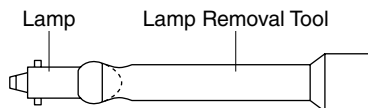

- Place the pins on the lamp base to the grooves in the lamp socket. Insert the lamp and turn it to the right.

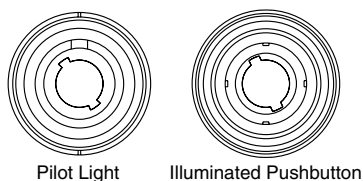

Pilot Light

Illuminated Pushbutton

Note: LED lamps in unibody pilot lights cannot be replaced.

Removing Contact Blocks and Full Voltage Adapters

Insert a flat screwdriver between the latch and contact block mounting adapter, and disengage the latch.

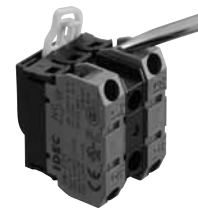

Make sure to remove the lamp and contact blocks before removing the full voltage adapter.

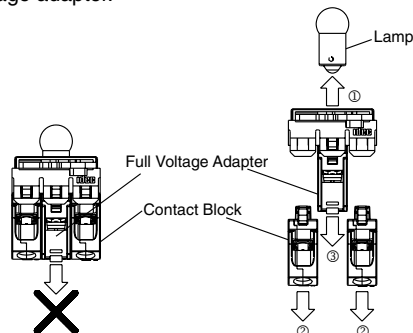

Tightening Torque for Terminal Screws

Tighten terminal screws to a torque of 1.0 N-m.

Anti-rotation Ring and Mounting Panel

Turn the TOP marking on the operator and the ▲ mark on the anti-rotation ring to the recess on the mounting panel.

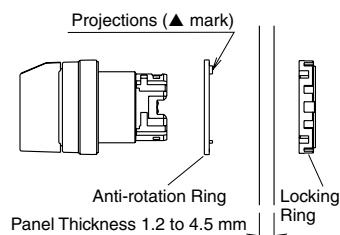

Mounting Panel Thickness

The mounting panel must be 0.8 to 6.0 mm in thickness. When optional accessories are added, the applicable panel thickness changes as shown below.

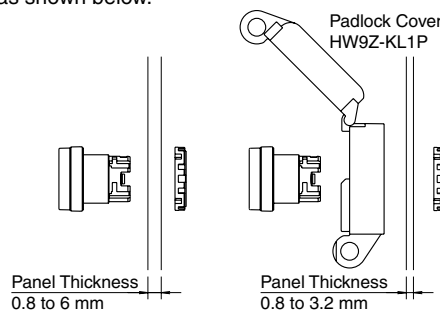

Contact Bounce

When pressing or turning the operator, the NC and NO contacts will bounce. When designing a control circuit, take the contact bounce time into consideration (reference value: 20 ms).

Precautions for Noise

When using the unibody pilot light in an environment where it is subjected to noise, connect a noise suppressor across terminals X1 and X2 as shown below.

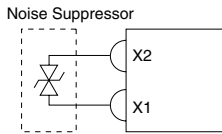

Key Selector Switch

Before operation, ensure that the key is inserted into the key hole completely. Operating the key selector switch with a loose key will cause damage to the key selector switch.

LED Illumination

LED lamps consist of semiconductors. If the applied voltage exceeds the rated voltage, LED elements deteriorate due to overheat, resulting in significant decrease in brightness, hue change, or failure of lighting. Also, if extraneous noise, transient voltage, or transient current is applied to the circuit, similar effects will be caused. When using LED lamps, observe the following instructions.

Rated Voltage

The LED illuminated units are rated at 6V, 12V, 24V, 110V, or 230/240V AC/DC, and can be used within $\pm 10\%$ the rated voltage of either AC or DC, except the 230/240V AC/DC types can be used on 250V AC/DC maximum.

DC Power

- Switching power supply
Regulated voltage from a switching power supply is best suited. Make sure to use within the rated voltage of the LED lamp.
- Rechargeable battery
Note that the battery voltage may exceed the rated voltage of the LED lamp while the battery is being charged and immediately after the charging is complete. Be sure to use the LED lamp on a voltage of $\pm 10\%$ the rated voltage, except the 230/240V AC/DC types on 250V AC/DC maximum.
- Full-wave rectification
Since the LED lamp is AC/DC compatible, a diode bridge for rectification is not necessary. If the LED lamp is used on a full-wave rectification current through a diode bridge, the rectifier diodes will reduce the voltage, resulting in lower brightness.
- Single-phase half-wave rectification
This is not suitable for the power source of LED lamps. Use constant-voltage DC power.

Noise

LED elements deteriorate due to extraneous noise, resulting in significant decrease in brightness, hue change, or failure of lighting. When such effects are anticipated, take a protection measure shown below, such as RC elements or a surge absorber.

Nameplate

When anti-rotation is not required, remove the projection from the nameplate using pliers.

Handling

Do not expose the switch to excessive shock and vibration, otherwise the switch may be deformed or damaged, causing malfunction or operation failure.

[Protection Example 1] For AC circuit

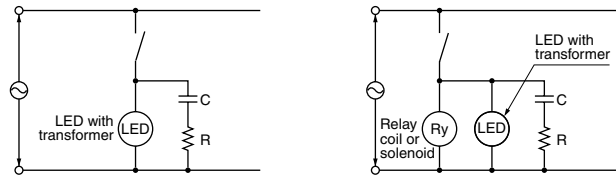

[Protection Example 2] For DC circuit

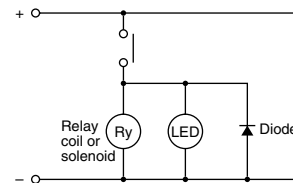

Countermeasures against Dim Lighting

- Leakage current through transistors or a contact protection circuit may cause the LED lamp to illuminate dimly even when the output is off.
- When the LED lamp is illuminated by a transistor output, take the following measure.

[Circuit Example]

Connect shunt resistor R in parallel with the LED lamp.

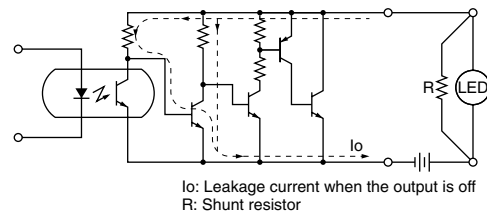

I₀: Leakage current when the output is off
R: Shunt resistor

Ordering Information

- When ordering, specify the Part No. and quantity.
- Replacement contact blocks are supplied in a package containing 10 pieces.

Specifications and other descriptions in this brochure are subject to change without notice.



IDEC CORPORATION

IDEC CORPORATION (USA)
1175 Elko Drive, Sunnyvale, CA 94089-2209, USA
Tel: +1-408-747-0550 / (800) 262-IDEC (4332)
Fax: +1-408-744-9055 / (800) 635-6246
E-mail: opencontact@idec.com

IDEC CANADA LIMITED
3155 Pepper Mill Court, Unit 4
Mississauga, Ontario, L5L 4X7, Canada
Tel: +1-905-890-8561, Toll Free: (800) 262-IDEC (4332)
Fax: +1-905-890-8562
E-mail: sales@ca.idec.com

IDEC AUSTRALIA PTY. LTD.
Unit 17, 104 Ferntree Gully Road,
Oakleigh, Victoria 3166, Australia
Tel: +61-3-8523-5900, Toll Free: 1800-68-4332
Fax: +61-3-8523-5999
E-mail: sales@au.idec.com

IDEC ELECTRONICS LIMITED
Unit 2, Beechwood, Chineham Business Park,
Basingstoke, Hampshire RG24 8WA, UK
Tel: +44-1256-321000, Fax: +44-1256-327755
E-mail: sales@uk.idec.com

IDEC ELEKTROTECHNIK GmbH
Wendenstrasse 331, 20537 Hamburg, Germany
Tel: +49-40-25 30 54 - 0, Fax: +49-40-25 30 54 - 24
E-mail: service@idec.de

IDEC (SHANGHAI) CORPORATION
Room 701-702 Chong Hing Finance Center,
No. 288 Nanjing Road West, Shanghai 200003, PRC
Tel: +86-21-6135-1515
Fax: +86-21-6135-6225 / +86-21-6135-6226
E-mail: idec@cn.idec.com

IDEC (BEIJING) CORPORATION
Room 211B, Tower B, The Grand Pacific Building,
8A Guanghua Road, Chaoyang District,
Beijing 100026, PRC
Tel: +86-10-6581-6131, Fax: +86-10-6581-5119

IDEC (SHENZHEN) CORPORATION
Unit AB-3B2, Tian Xiang Building, Tian'an Cyber Park,
Fu Tian District, Shenzhen, Guang Dong 518040, PRC
Tel: +86-755-8356-2977, Fax: +86-755-8356-2944

6-64, Nishi-Miyahara 2-Chome, Yodogawa-ku, Osaka 532-0004, Japan
Tel: +81-6-6398-2527, Fax: +81-6-6398-2547
E-mail: marketing@idec.co.jp

IDEC IZUMI (H.K.) CO., LTD.
Unit G & H, 26/F, MG Tower,
No. 133 Hoi Bun Road, Kwun Tong, Kowloon,
Hong Kong
Tel: +852-2803-8989, Fax: +852-2565-0171
E-mail: info@hk.idec.com

IDEC TAIWAN CORPORATION
8F-1, No. 79, Hsin Tai Wu Road, Sec. 1,
Hsi-Chih District, 22101 New Taipei City, Taiwan
Tel: +886-2-2698-3929, Fax: +886-2-2698-3931
E-mail: service@tw.idec.com

IDEC IZUMI ASIA PTE. LTD.
No. 31, Tannery Lane #05-01,
HB Centre 2, Singapore 347788
Tel: +65-6746-1155, Fax: +65-6844-5995
E-mail: info@sg.idec.com

IDEC ASIA (THAILAND) CO., LTD.
Unit AB-3B2, Sorachai Bldg., No.23/78,
Soi Sukhumvit 63, Sukhumvit Rd.,
Klongkum-nua, Wattana, Bangkok 10110
Tel: +662-392-9765, Fax: +662-392-9768
E-mail: sales@th.idec.com