

Description	Page Number
100T Push Buttons:	
General Information.....	D2
Push Buttons - Std. & Mushrooms	D4
Key Operated - Push Pull Push Buttons.....	D5
Illuminated Push Buttons.....	D6
Illuminated Push Pull Units.....	D7
Pilot Lights & Press-to-Test Pilot Lights.....	D8
Selector Switches: 2 - 3 - 4 Position	D9
Assembled Push Button Units	D10
Assembled Stations: 1 - 2 - 3 Elements	D11
Assembled Selector Switch Units	D12
Separate Enclosures: 1 - 5 Hole	D13
Legend Plates	D14
Accessories	D15
Dimensions & Ratings	D16
Catalog Numbering System	D17 - D18

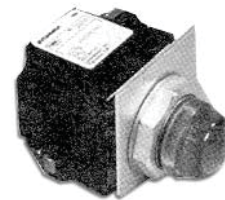

D

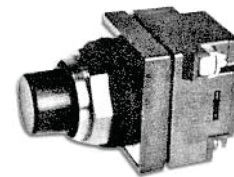

Joslyn Clark Type 100T Heavy Duty Push Buttons are available in Standard, Mushroom Head, Push Pull, and Key-Operated.

All units are suitable for use in NEMA Type 1, 3, 3R, 4, 4X, 12, and 13 applications when mounted in enclosures rated for those same applications. Although not needed on all Type 4X applications, protective caps provide improved resistance to some corrosive materials. They are not required by UL.

NEMA 13 Oiltight and NEMA 4 Watertight integrity is assured by a unique collapsing neoprene diaphragm. Three neoprene gaskets in back of the panel insure a tight fit and flexibility for different thickness enclosures. The die cast housing fits both standard Oiltight mounting holes with a 1-13/64" or 30.56mm diameter.

Single circuit double break contact blocks are made of tough clear plastic for easy contact inspection. Blocks are attached to the operator by a single captive screw and positioning pin to make installation quick and easy. Up to 8 blocks may be stacked on each push button operator (2 wide, 4 deep). Up to 6 blocks on each selector switch.

Brushed aluminum legend plates are held in place by a locking thrust washer which extends through the plate into the panel for easy alignment. Standard legend plates are 1-7/8" square with black etched in letters. Jumbo automotive size 2-1/2" square legends are also available.

Standard Operators

Interchangeable snap-on, reusable tough molded-in-plastic cups, are available in black, red, green, yellow, amber, blue, white, and brown. Your choice of three octagonal, brushed aluminum guard rings comes in:

Unguarded - Button extends beyond ring for easy access.

Guarded - Ring is flush with button to prevent accidental operation.

Extended - Ring extends beyond button Guard making accidental operation unlikely.

Standard and Jumbo Mushroom Head

Both mushroom heads fit the same operator and come in black, red, green, and yellow. The diameter of the standard head is 1-3/8" - jumbo head is 2-1/4" in diameter.

Illuminated Push Button

Plastic Lens are available in seven colors and in standard and mushroom head (1³/₈" variety. The operator combines a momentary push button and pilot light in one unit.

Push-Pull

Both Illuminated and Non-Illuminated standard mushroom heads are available in 2 position maintained operators.

Key-Operated

When the key-type cylinder lock is depressed with or without key inserted - the operator is locked down and can only be released by the key. A red jumbo mushroom head can be field or factory installed for emergency stop applications. Other types of key operations are obtainable.



Joslyn Clark Type 100T Heavy Duty Selector Switches are available in Standard Knob, Chrome Lever, Key-Operated, Joy Stick and Selector-Push.

The standard knob and chrome lever switches are obtainable with two, three and four position operators. They come in: 2 position maintained and spring return; 3 position maintained, spring return from right to center, left to center, right and left to center; and 4 position maintained.

Key operated switches come in two or three position maintained and spring return and all 4 position switches are maintained.

There are several cams for all selector switches in order to accomplish numerous types of circuits. Positive indexing assures operating reliability.

Up to eight single circuit contact blocks - four on either side - may be attached to any operator with a single captive screw and positioning pin on each block.

A tip on the locking thrust washer extends through the legend plate to the panel, locking both plate and operator in position.

Legend plates are of brushed aluminum with etched black lettering. An octagonal aluminum guard ring locks operator on the panel adding to the look of quality.

Standard Knob

Interchangeable knobs are of high-impact plastic in black, red, green, yellow and blue. They fit tightly to an inner white knob which provides an easy-to-see white index mark for the cap.

Standard Knob Illuminated Selector Switch

Available with seven interchangeable colored lenses in both two position maintained and three position maintained and spring return.



Selector Switches

Chrome Lever

These selector switches have the same operating characteristics as the Standard Knob model. An extended chrome lever, 1-3/4" long, provides quick and positive operation with or without gloves.

Key-Operated

Key-operated switches have the same positive action as the Standard Knob and Chrome Lever types. Operators are obtainable with many key removal positions. There are special keys available for added security.

Joy Stick

All 3 position and 5 position maintained and spring return joy sticks have the same positive action as the other selector switches. A special joy stick model can be supplied with a release button on top. This prevents movement of the joy stick until the button is depressed - an excellent safety feature.

Selector-Push

Selector-Push operators combine the actions of a selector switch and momentary push button. A rotating collar provides the selectivity needed to provide for several functions in one operator.

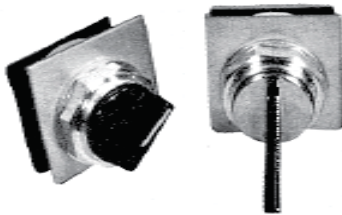

Pilot Lights

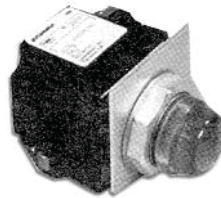

Joslyn Clark Type 100T Heavy Duty Pilot Lights are available in Standard and Press-To-Test. A choice of power configurations to match various shock and vibration levels insure longer lamp life. Plastic lenses come in red, green, yellow, amber, blue, white and clear. All lamps have bayonet type bases.

There are four basic power configurations.

- 1. Transformer Type (120, 240 or 480 Volts)** uses a modular heavy-duty transformer - 50 or 60 Hertz - to step line voltage down to 6 volts for longer lamp life under high shock and vibration conditions.
- 2. Resistor Type (120 or 240 Volts)** drops voltage to 60 and 120 volts respectively to lengthen lamp life in less severe applications.
- 3. Full-Voltage Types (6, 12, 24 or 120 Volts)** are used in applications with little shock or vibration. AC and DC rated.
- 4. Neon Type (120 Volts)** will withstand extremely heavy shock and vibration conditions - use of clear and yellow lens is recommended. AC and DC rated.

Standard

Dome Lenses are made of thick plastic, fluted to give wide visibility. They come in red, green, yellow, amber, blue, white and clear.

Press-To-Test

Features and colors are the same as Standard Pilot Lights except the lenses are tubular. A N.O. and a N.C. contact block comes with unit.

Contact Blocks (600 Volt)

Features

- Contacts enclosed in a clear plastic housing
- Fine silver contact tips
- Long life steel springs
- Same contact block for all operators
- "Quick-Stack" assembly
- "Easy-Access" terminals
- "One-Block-At-A-Time" removal
- Easy contact mode identification
- UL listed

Joslyn Clark Type 100T Heavy Duty Contact Blocks are designed to simplify installation and assure trouble-free operation.

Contacts are enclosed in sturdy plastic to prevent foreign material from entering the block. The clear plastic allows easy contact inspection. Contact tips are made of fine silver for high conductivity. Strong resilient springs reduce contact bounce and assure long reliable operation. The 3/4" blocks may be used on all operators installed side by side and four in tandem.

The single No. 8 tapped-head captive screw and positioning pin on each block make stacking fast and easy. Terminals are inclined for direct access and speedy wiring also angled to provide extra wiring room. A self-rising saddle assures a solid vibration resistant connection at each terminal for two No. 12 copper wires. Individual block removal is automatic without possibility of the entire stack coming off when the top block is removed.

Contact mode is readily identified. Normally-Open contact blocks have green operators marked with both N.O. and NO symbol. The normally-closed blocks have red operators and are marked with N.C. and NC symbol.



D

Push Buttons



Extended Pushbutton



Flush Pushbutton



1-3/8 inch Mushroom Head

Pushbuttons Momentary Operation

NEMA Type 1, 4, 12, 13		
Operator	Color	Catalog Number
Extended	Black	100T-PB1B
	Red	100T-PB1R
	Green	100T-PB1G
	Yellow	100T-PB1Y
	Amber	100T-PB1A
	Blue	100T-PB1E
	White	100T-PB1W
	Brown	100T-PB1N
	None	100T-PB10
	Flush	Black
Red		100T-PB2R
Green		100T-PB2G
Yellow		100T-PB2Y
Amber		100T-PB2A
Blue		100T-PB2E
White		100T-PB2W
Brown		100T-PB2N
None		100T-PB20
1-3/8 inch Mushroom		Black
	Red	100T-PB4R
	Green	100T-PB4G
	Yellow	100T-PB4Y
	None	100T-PB40
2-1/4 inch Mushroom	Black	100T-PB5B
	Red	100T-PB5R
	Green	100T-PB5G
	Yellow	100T-PB5Y

Standard Contact Blocks

Type	Symbol	Rod Color	Catalog Number
1-N.O.		Green	100T-CB10
1-N.C.		Red	100T-CB01 100T-CBH01 ²
Standard Contact Block	1-N.O. & 1-N.C.	1-Green & 1-Red	100T-CB11 ¹

1. Consists of one 100T-CB10 and one 100T-CB01 packaged together.
2. Additional spring pressure for resistance to vibration.

Contact Ratings

NEMA Rating Desig.	Max. Volts	Amps.			VA.	
		Make	Break	Continuous	Make	Break
Maximum A-C Contact Rating Per Pole, 50 or 60 Hertz.						
A600	120	60	6	10	7200	720
	240	30	3			
	480	15	1.5			
	600	12	1.2			
Maximum D-C Contact Rating Per Pole						
P600	125	1.1		5	138	120
	250	0.55				
	301-600	0.2				

Pushbutton Color Caps and Mushroom Head

	Color Caps for Flush Unguarded or Guarded Push Buttons	1-3/8 inch Mushroom Head for Mushroom Buttons and Push Pull Units	2-1/4 inch Mushroom Head for Mushroom Buttons and Push Pull Units
Color	Catalog Number	Catalog Number	Catalog Number
Black	100T-BB	100T-BM4B	100T-BM5B
Red	100T-BR	100T-BM4R	100T-BM5R
Green	100T-BG	100T-BM4G	100T-BM5G
Yellow	100T-BY	100T-BM4Y	100T-BM5Y
Amber	100T-BA		
Blue	100T-BE		
White	100T-BW		
Brown	100T-BN		
Mixed	100T-BM	100T-BM4M	

Selection Guide

Select push button operators from table above and contact blocks from table on the right. Select legend plates from page D16.

For complete units see page D13. All units on this page will accept a total of eight contact blocks.

Item	Page	Item	Page
Accessories	D17	Pilot Lights	D7
Legend Plates	D16	Selector Switches	D8
Ratings and Dimensions	D18	Special Devices	D4
Assembled Units	D13	Assembled Stations	D13

Ordering Information

Complete Control Unit Consists Of:



Operator 100T-PB2B

+



Contact Blocks 100T-CB01

+

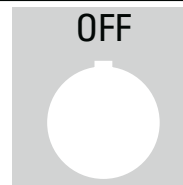

Legend Plate 100T-L07

=

Complete Push Button Unit

Special Purpose Push Button Units

Key Operated Push Button

This key operated push button is a chrome, unguarded unit that locks in the depressed position. It must be unlocked with a key to release it. Two keys are provided with each unit.



Key Operated Push Button

Description ¹	Catalog No.
Unit Locks in Depressed Position Key Required to Release Chrome Unit	100T-PB61 Legend Plate & Contact Blocks Not Included

1. 100T-BM6R 2 1/4 inch Red Mushroom Head available for this unit.

Standard Contact Blocks

Type	Symbol	Rod	Catalog
		Color	Number
1-N.O.		Green	100T-CB10
1-N.C.		Red	100T-CB01 100T-CBH01 ³
1-N.O. & 1-N.C.		1-Green & 1-Red	100T-CB11 ²

2. Consists of one 100T-CB10 and one 100T-CB01 packaged together.
3. Additional spring pressure for resistance to vibration.

Item	Page
Accessories	D17
Legend Plates	D16
Ratings and Dimensions	D18

Push-Pull Units

Push-Pull units are available as two position, maintained (buttons remain in the depressed position until manually released). Standard units have 1 3/8 inch mushroom head operator.

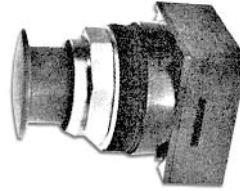

Push-Pull Unit

Push-Pull Units

Comes with 1 3/8 inch Standard Mushroom Head. Legend Plate and Contact Blocks not included.

Description	Color ⁴	Catalog Number
Maintained	Black	100T-PP4B
	Red	100T-PP4R
	None	100T-PP40

1. For colors not listed, or for units with 2 1/4 inch diameter Mushroom Heads, order with "none" and select desired Mushroom Head from below.

Mushroom Head Color Caps

	1-3/8 inch Mushroom Head for Mushroom Buttons and Push Pull Units	2-1/4 inch Mushroom Head for Mushroom Buttons and Push Pull Units
Color	Catalog Number ⁵	Catalog Number ⁶
Black	100T-BM4B	100T-BM5B
Red	100T-BM4R	100T-BM5R
Green	100T-BM4G	100T-BM5G
Yellow	100T-BM4Y	100T-BM5Y
Mixed	100T-BM4M	100T-BM5M

5. Packaged 1 per carton except 100T-BM4M contains one of each color.

6. Packaged 1 per carton except 100T-BM5M contains one of each color.

Ordering Information

Complete Control Unit Consists Of:

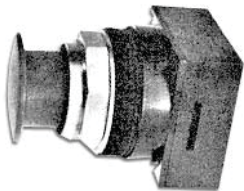

Operator
100T-PP4B

+



Contact Blocks
100T-CB01

+

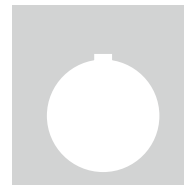

Legend Plate
100T-L30

=

Complete Push Button Unit

100T

Push Buttons



Illuminated Push Buttons

Illuminated Momentary Push Buttons comes with Standard Lens.
Legend Plate and Contact Blocks Not Included.

Operator & Lenses
100T-PBLT1R

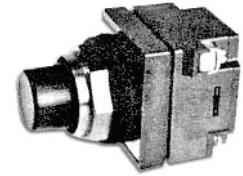

Type	Voltage	Lamp Number	Lens Color	Catalog Number ¹
Transformer	120 AC only 50/60 Hz	755	Red	100T-PBLT1R
			Green	100T-PBLT1G
			None	100T-PBLT10
	240 AC only 50/60 Hz	755	Red	100T-PBLT2R
			Green	100T-PBLT2G
			None	100T-PBLT20
480 AC only 50/60 Hz	755	Red	100T-PBLT4R	
		Green	100T-PBLT4G	
		None	100T-PBLT40	
Resistor	120 AC DC	60MB	Red	100T-PBLR1R
			Green	100T-PBLR1G
			None	100T-PBLR10
	240 AC DC	120MB	Red	100T-PBLR2R
			Green	100T-PBLR2G
			None	100T-PBLR20
Full Voltage	120 AC DC	120MB	Red	100T-PBLF1R
			Green	100T-PBLF1G
			None	100T-PBLF10
	6 AC DC	6MB	Red	100T-PBLF6R
			Green	100T-PBLF6G
			None	100T-PBLF60
	12 AC DC	12MB	Red	100T-PBLF7R
			Green	100T-PBLF7G
			None	100T-PBLF70
	24 AC DC	24MB	Red	100T-PBLF8R
			Green	100T-PBLF8G
			None	100T-PBLF80
Neon ²	120 AC DC	NE51	Yellow	100T-PBLN1Y
			Clear	100T-PBLN1C
			None	100T-PBLN10

- Catalog number with lens are for standard lens. For colors not listed, or for 1 3/8 inch mushroom lens, order with "none" and select desired standard or mushroom lens from table at right.
- Yellow or clear lens only recommended for neon unit.

Item	Page
Accessories	D17
Legend Plates	D16
Ratings and Dimensions	D18
Assembled Units	D13

Replacement Lamps	
Voltage	Catalog #
6V	080 MB1
12V	080 MB2
24V	080 MB3
48V	080 MB5
120V	080 MB7

Selection Guide

Select Illuminated push button operators from table at left and contact blocks from below. Units without lenses will accept either standard lens or mushroom lens. All units are provided with "unguarded" guard ring. Clear plastic guard 100T-PGR is available.

Select legend plates from page D16

For complete units, see page D13

All units on this page will accept a total of eight contact blocks.

Standard Contact Blocks

Type	Symbol	Rod Color	Catalog Number
1-N.O.		Green	100T-CB10
1-N.C.		Red	100T-CB01 100T-CBH01 ⁴
Standard Contact Block & 1-N.C.		1-Green & 1-Red	

3. Consists of one 100T-CB10 and one 100T-CB01 packaged together.

4. Additional spring pressure for resistance to vibration.

Standard Lenses and Mushroom Lenses

	Standard Lenses for Guarded or Unguarded Push Buttons or Press-to-Test Pilot Lights	1-3/8 inch Mushroom Lenses for Illuminated Push Buttons and Illuminated Push-Pull Units
Color	Catalog Number	Catalog Number
Red	100T-LBR	100T-LBMR
Green	100T-LBG	100T-LBMG
Yellow	100T-LBY	100T-LBMY
Amber	100T-LBA	100T-LBMA
Blue	100T-LBE	100T-LBME
White	100T-LBW	100T-LBMW
Clear	100T-LBC	100T-LBMC
Mixed	100T-LBM	100T-LBMM

5. Packaged one per carton except 100T-LBM contains seven lenses, one of each color.

6. Packaged one per carton except 100T-LBMM contains seven lenses, one of each color.

Ordering Information

Complete Control Unit Consists Of:

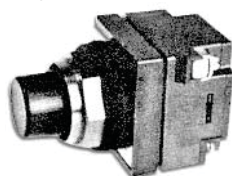

Operator
100T-PBLT1R

+



Contact Blocks
100T-CB01

+

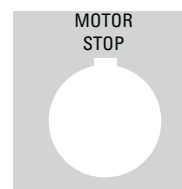

Legend Plate
100T-L92

=

Complete
Push Button
Unit



Illuminated Push-Pull Units

Illuminated Push-Pull Units (Maintained Position) Comes With and Without 1 3/8 inch Mushroom Head.
Legend Plate and Contact Blocks Not Included.

Type	Voltage	Lamp Number	Lens Color	Catalog Number ¹
Transformer	120 AC only 50/60 Hz	755	Red	100T-PPLT1R
			Green	100T-PPLT1G
			None	100T-PPLT10
	240 AC only 50/60 Hz	755	Red	100T-PPLT2R
			Green	100T-PPLT2G
			None	100T-PPLT20
480 AC only 50/60 Hz	755	Red	100T-PPLT4R	
		Green	100T-PPLT4G	
		None	100T-PPLT40	
Resistor	120 AC DC	60MB	Red	100T-PPLR1R
			Green	100T-PPLR1G
			None	100T-PPLR10
	240 AC DC	120MB	Red	100T-PPLR2R
			Green	100T-PPLR2G
			None	100T-PPLR20
Full Voltage	120 AC DC	120MB	Red	100T-PPLF1R
			Green	100T-PPLF1G
			None	100T-PPLF10
	6 AC DC	6MB	Red	100T-PPLF6R
			Green	100T-PPLF6G
			None	100T-PPLF60
	12 AC DC	12MB	Red	100T-PPLF7R
			Green	100T-PPLF7G
			None	100T-PPLF70
	24 AC DC	24MB	Red	100T-PPLF8R
			Green	100T-PPLF8G
			None	100T-PPLF80
Neon ²	120 AC DC	NE51	Yellow	100T-PPLN1Y
			Clear	100T-PPLN1C
			None	100T-PPLN10

1. For colors not listed, order with "none" and select desired mushroom lens form table at right.
2. Yellow or clear lens only recommended for neon unit.

Item	Page
Accessories	D17
Legend Plates	D16
Ratings and Dimensions	D18

Operator & Lenses
100T-PPLT1R

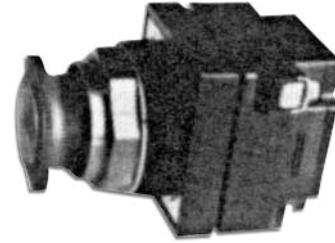

Selection Guide

Illuminated push-pull units are two position illuminated mushroom buttons which remain in the depressed position until manually released. Select the operator from table at left and contacts from below. Select legend plate from page D16.

All units on this page will accept a total of eight contact blocks.

Standard Contact Blocks

Type	Symbol	Rod		Catalog Number
		Color		
1-N.O.		Green		100T-CB10
1-N.C.		Red		100T-CB01 100T-CBH01 ⁴
1-N.O. & 1-N.C.		1-Green & 1-Red		100T-CB11 ³

3. Consists of one 100T-CB10 and one 100T-CB01 packaged together.
4. Additional spring pressure for resistance to vibration.

Mushroom Lenses for Illuminated Push-Pull Units

Color	1 3/8 inch Mushroom Lenses for Illuminated Push-Pull Units	
	Catalog Number	
Red	100T-LBMR	
Green	100T-LBMG	
Yellow	100T-LBMY	
Amber	100T-LBMA	
Blue	100T-LBME	
White	100T-LBMW	
Clear	100T-LBMC	
Mixed	100T-LBMM	

5. Packaged one per carton except 100T-LBMM contains seven lenses, one of each color.

Ordering Information

Complete Control Unit Consists Of:



Operator
100T-PPLT1R

+



Contact Blocks
100T-CB01

+

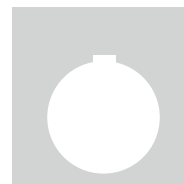

Legend Plate
100T-L30

=

Complete
Push Button
Unit



Pilot Lights and Press-To-Test Pilot Lights

				Pilot Lights ⁴	
Type	Voltage	Lamp Number	Lens Color	Catalog Number ¹	Press-To-Test ⁴ Catalog Number ³
Transformer	120 AC only 50/60 Hz	755	Red	100T-PLT1R	100T-PTT1R
			Green	100T-PLT1G	100T-PTT1G
			None	100T-PLT10	100T-PTT10
	240 AC only 50/60 Hz	755	Red	100T-PLT2R	100T-PTT2R
			Green	100T-PLT2G	100T-PTT2G
			None	100T-PLT20	100T-PTT20
480 AC only 50/60 Hz	755	Red	100T-PLT4R	100T-PTT4R	
		Green	100T-PLT4G	100T-PTT4G	
		None	100T-PLT40	100T-PTT40	
Resistor	120 AC DC	60MB	Red	100T-PLR1R	100T-PTR1R
			Green	100T-PLR1G	100T-PTR1G
			None	100T-PLR10	100T-PTR10
	240 AC DC	120MB	Red	100T-PLR2R	100T-PTR2R
			Green	100T-PLR2G	100T-PTR2G
			None	100T-PLR20	100T-PTR20
Full Voltage	120 AC DC	120MB	Red	100T-PLF1R	100T-PTF1R
			Green	100T-PLF1G	100T-PTF1G
			None	100T-PLF10	100T-PTF10
	6 AC DC	6MB	Red	100T-PLF6R	100T-PTF6R
			Green	100T-PLF6G	100T-PTF6G
			None	100T-PLF60	100T-PTF60
	12 AC DC	12MB	Red	100T-PLF7R	100T-PTF7R
			Green	100T-PLF7G	100T-PTF7G
			None	100T-PLF70	100T-PTF70
	24 AC DC	24MB	Red	100T-PLF8R	100T-PTF8R
			Green	100T-PLF8G	100T-PTF8G
			None	100T-PLF80	100T-PTF80
Neon ²	120 AC DC	NE51	Yellow	100T-PLN1Y	100T-PTN1Y
			Clear	100T-PLN1C	100T-PTN1C
			None	100T-PLN10	100T-PTN10

- For colors not listed, order with "none" and select desired lens from table below.
- Yellow or clear lens only recommended for neon unit.
- Catalog number with lens are for standard lens. For colors not listed or for 1 3/8 inch mushroom lens order with "none" and select desired standard or mushroom lens from table below.
- Legend Plate Not Included.
- For Replacement Lamps see page D6.

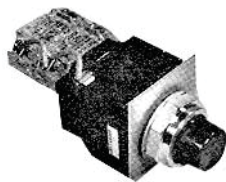

Press-To-Test Pilot Light
Operator & Lens
100T-PTT1R

Standard Lens

Pilot Light
Operator & Lens
100T-PLT1R

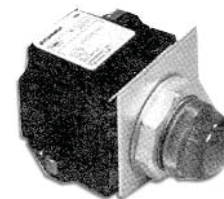

Pilot Light

Pilot Lights are available in four different power configurations- transformer, resistor, full voltage and neon types. Transformer types are available with 480, 240, and 120 volt primary voltages and all have a 6.3 volt secondary for long lamp life. They will withstand a considerable amount of shock and vibration. The resistor type is available in 240 and 120 volt varieties with the resistor dropping the voltage to 120 and 60 volts respectively. Full voltage units are available with 6, 12, 24, and 120 volt lamps. The neon bulbs burn less brightly therefore it is recommended that only yellow and clear lens be used for these units.

Press-To-Test Lights

Press-To-Test Lights are available in the same four power configurations as the standard pilot lights - Transformer, resistor, full voltage, and neon. They are furnished pre-wired with a normally open and a normally closed contact. As shown in the diagram below it will allow you to test the lamp without interfering with the normal operation of the pilot light.

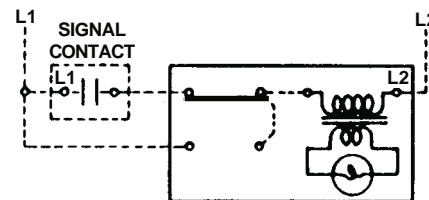

Standard Lenses and Mushroom Lenses

Color	Standard Lenses for Pilot Lights (Purchased after Jan. 1997)	Standard Lenses for Guarded or Unguarded Buttons or Press-To-Test Pilot Lights	1 3/8 inch Mushroom Lenses for Illuminated Press-To-Test Pilot Lights
	Catalog Number	Catalog Number	Catalog Number
Red	100T-LR	100T-LBR	100T-LBMR
Green	100T-LG	100T-LBG	100T-LBMG
Yellow	100T-LY	100T-LBY	100T-LBMY
Amber	100T-LA	100T-LBA	100T-LBMA
Blue	100T-LE	100T-LBE	100T-LBME
White	100T-LW	100T-LBW	100T-LBMW
Clear	100T-LC	100T-LBC	100T-LBMC
Mixed	100T-LM	100T-LBM	100T-LBMM

5. Packaged 1 per carton except 100T-LM contains seven lenses one of each color.
6. Packaged 1 per carton except 100T-LBM contains seven lenses one of each color.
7. Packaged 1 per carton except 100T-LBMM contains seven lenses one of each color.



Selector Switches 2-3-4 Position Non-Illuminated

Selector Switches

Legend Plate and Contact Blocks not included

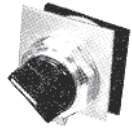

**Black Knob
100T-SS2MB1**

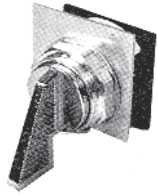

**Chrome Lever
100T-SL2MC1**



**Key Operated
100T-SK3M**

Type	Black Knob Operator ^{1,2}		Chrome Lever Operator		Key Operator		
	Catalog Number	Cam ³ Code	Catalog Number	Cam ³ Code	Catalog Number	Cam ³ Code	Key ⁴ Removal
2 Positioned Maintained	100T-SS2MB	1	100T-SL2MC	1	100T-SK2M	1	A
2 Position Spring Return Right To Center	100T-SS2RB	1	100T-SL2RC	1	100T-SK2R	1	C
3 Positioned Maintained	100T-SS3MB	3,4,5, 6, or 7	100T-SL3MC	3,4,5, 6, or 7	100T-SK3M	3,4,5, 6, or 7	A
3 Position Spring Return Right To Center	100T-SS3RB	3,4,5, 6, or 7	100T-SL3RC	3,4,5, 6, or 7	100T-SK3R	3,4,5, 6, or 7	C
3 Position Spring Return Left To Center	100T-SS3LB	3,4,5, 6, or 7	100T-SL3LC	3,4,5, 6, or 7	100T-SK3L	3,4,5, 6, or 7	C
3 Position Spring Return Rt. & Lt. to Ctr.	100T-SS3BB	3,4,5, 6, or 7	100T-SL3BC	3,4,5, 6, or 7	100T-SK3B	3,4,5, 6, or 7	C
4 Position Maintained	100T-SS4MB	8	100T-SL4MC	8	100T-SK4M	8	A

1. Available in other colors Change "B" in operator catalog number to "R" for Red, "G" for Green, "Y" for Yellow, or "E" for Blue.
2. Available without Knob Change "B" in operator Catalog number to "O" and select knob from table below.
3. Cam code is a part of catalog number: Example 100T-SS3MB3 See table of cam developments.
4. Key Removal code is part of catalog number. Example: 100T-SK3B3C See Key Removal table below.

Key Spare Parts

- For Standard Key Operator use 100T-3095
- For 501 Key Operator use 100T-CH501

Key Removal Codes

Key Removal Code	Two Position				Three Position			Four Position			
	Maintained		Spring Return		Left	Center	Right	Left	Left Center	Right Center	Right
	Left	Right	Center	Right							
L (Left)	Yes	No	-----	-----	Yes	No	No	Yes	No	No	No
R (Right)	No	Yes	No	Yes	No	No	Yes	No	No	No	Yes
C (Center)	-----	-----	Yes	No	No	Yes	No	-----	-----	-----	-----
A (All)	Yes	Yes	Yes	Yes	Yes	Yes	Yes	Yes	Yes	Yes	Yes

Notes: No 501 Key is available for above Key Operators Selector Switches. To order add "5" for 501 Key to the end of the catalog number. Example: 100T-SK2M1A5.

Color Plastic Knobs

Standard Plastic Knob for Knob Operated Selector Switches	
Color	Catalog Number
Black	100T-SB
Red	100T-SR
Green	100T-SG
Yellow	100T-SY
Blue	100T-SE
Mixed	100T-SM

Packaged one per carton except 100T-SM contains one of each color knob.

Ordering Information

Complete Control Unit Consists Of:

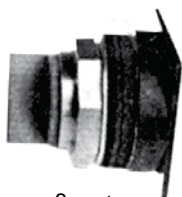

Operator
100T-SS2MB1

+



Contact Blocks
100T-CB01

+

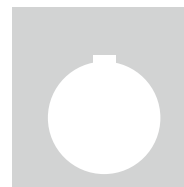

Legend Plate
100T-L52

=

Complete
Push Button
Unit

100T

Push Buttons



Selector Switches Contact Block Switching Sequence and Selection

2 Position Selector Switch

Location of Contact Block (Front View)		Contact Block			Selector Position Cam Code 1			
					Maintained		Spring Return	
		Catalog Number 100T-	Symbol	Rod Color	Left	Right	Center	Right
Left	N.O.	CB10	<u>○</u> , ○	Green	○	X	○	X
	N.C.	CB01	○ <u>○</u>	Red	X	○	X	○
Right	N.O.	CB10	<u>○</u> , ○	Green	○	X	○	X
	N.C.	CB01	○ <u>○</u>	Red	X	○	X	○



Cam codes are same for maintained or spring return operation.

X = Contact Closed
○ = Contact Open

3 Position Selector Switch

Location of Contact Block (Front View)		Contact Block			Selector Position Cam Code 3			Selector Position Cam Code 4			Selector Position Cam Code 5			Selector Position Cam Code 6			Selector Position Cam Code 7			
					Left	Center	Right	Left	Center	Right	Left	Center	Right	Left	Center	Right	Left	Center	Right	
		Catalog Number 100T-	Symbol	Rod Color	Left	Center	Right	Left	Center	Right	Left	Center	Right	Left	Center	Right	Left	Center	Right	
Left	N.O.	CB10	<u>○</u> , ○	Green	○	○	X	○	○	X	X	○	○	○	○	○	X	○	○	X
	N.C.	CB01	○ <u>○</u>	Red	X	○	○	○	X	○	○	X	○	X	○	X	○	X	○	○
Right	N.O.	CB10	<u>○</u> , ○	Green	○	○	X	○	○	X	X	○	○	X	○	○	○	○	○	X
	N.C.	CB01	○ <u>○</u>	Red	X	○	○	○	X	○	○	X	○	○	X	X	○	X	○	○

Cam Codes are the same for maintained or spring return operation.

X = Contact Closed
○ = Contact Open

Item	Page
Accessories	D17
Legend Plates	D16
Ratings and Dimensions	D18
Assembled Units	D14

Standard Contact Blocks

Type	Symbol	Rod Color	Catalog Number
1-N.O.	<u>○</u> , ○	Green	100T-CB10
1-N.C.	○ <u>○</u>	Red	100T-CB01 100T-CBH01 ²
1-N.O. & 1-N.C.	<u>○</u> , ○ ○ <u>○</u>	1-Green & 1-Red	100T-CB11 ¹

- Consists of one 100T-CB10 and one 100T-CB01 packaged together.
- Additional spring pressure for resistance to vibration.

4 Position Selector Switch

Location of Contact Block (Front View)		Contact Block			Selector Position Cam Code 8			
					Left	Left Center	Right Center	Right
		Catalog Number 100T-	Symbol	Rod Color	Left	Left Center	Right Center	Right
Left	N.O.	CB10	<u>○</u> , ○	Green	○	○	X	○
	N.C.	CB01	○ <u>○</u>	Red	X	○	○	○
	N.O.	CB10	<u>○</u> , ○	Green	○	X	○	○
Right	N.C.	CB01	○ <u>○</u>	Red	○	○	○	X

Cam codes are same for maintained or spring return operation.

X = Contact Closed
○ = Contact Open



Assembled Push Buttons

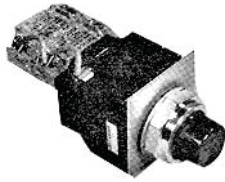

Assembled Push Buttons, including Contact Blocks as shown.
(Does not include Legend Plate)

Operator	Type	Symbol	Red Color	Catalog Number
Unguarded	1-N.O.		Black	100T-PB1B-10X
	1-N.C.		Red	100T-PB1R-01X
	1-N.C.		Black	100T-PB1B-11X
	1-N.O.		Red	100T-PB1R-11X
Guarded	1-N.O.		Black	100T-PB2B-10X
	1-N.C.		Black	100T-PB2B-11X
			Red	100T-PB2R-11X
1-N.O.		Green	100T-PB2G-11X	
1 3/8" Mushroom	1-N.C.		Black	100T-PB4B-11X
	1-N.O.		Red	100T-PB4R-11X
2 1/4" Mushroom	1-N.C.		Black	100T-PB5B-11X
	1-N.O.		Red	100T-PB5R-11X
Illuminated Push Button 120V Transformer Type	1-N.C.		Red	100T-PBLT1R-11X
	1-N.O.			
Illuminated Push Button 120V Resistor Type	1-N.C.		Red	100T-PBLR1R-11X
	1-N.O.			



Assembled 100T Push Button Stations

The most commonly used push button stations are available assembled in NEMA Type 13 (oiltight and dusttight) sheet steel and in NEMA 4 (watertight) stainless steel enclosures.

For custom control stations not listed, order operators, contact blocks, nameplates, and enclosures as separate items.

Assembled Push Buttons Stations

Assembled Push Buttons Stations In Surface mounted Enclosures

Description of Elements	NEMA 13 ¹ Sheet Steel	NEMA 4 ² Stainless Steel
	Catalog Number	Catalog Number
Single element Stations START (black guarded push button)	100T-S1-1	100T-W1-1
START (black 2 1/4" mushroom push button)	100T-S1-2	100T-W1-2
STOP (red unguarded push button)	100T-S1-3	100T-W1-3
STOP (red Mushroom unguarded push button with lockdown)	100T-S1-4	100T-W1-4
STOP (red 2 1/4" mushroom push button)	100T-S1-5	100T-W1-5
OFF-ON (black knob selector switch)	100T-S1-6	100T-W1-6
HAND-OFF-AUTO (black knob selector switch)	100T-S1-7	100T-W1-7
FWD-OFF-REV (black knob selector switch)	100T-S1-8	100T-W1-8
Two Element Stations START-STOP (black guarded-red unguarded push buttons)	100T-S2-1	100T-W2-1
START-STOP (black guarded-red 1 3/8" mushroom push buttons)	100T-S2-2	100T-W2-2
FORWARD-REVERSE (black guarded-black guarded push buttons)	100T-S2-3	100T-W2-3
OPEN-CLOSE (black guarded-black guarded push buttons)	100T-S2-4	100T-W2-4
UP-DOWN (black guarded-black guarded push buttons)	100T-S2-5	100T-W2-5
Three Element Stations FORWARD-REVERSE-STOP (black guarded-black guarded-red unguarded push buttons)	100T-S3-1	100T-W3-1
OPEN-CLOSE-STOP (black guarded-black guarded-red unguarded push buttons)	100T-S3-2	100T-W3-2
UP-DOWN-STOP (black guarded-black guarded-red unguarded push buttons)	100T-S3-3	100T-W3-3
START-STOP-JOG (black guarded-red unguarded-black guarded push buttons)	100T-S3-4	100T-W3-4
START-STOP-MOTOR RUN (black guarded-red unguarded push buttons-red 120 volt transformer unguarded pilot light)	100T-S3-5	100T-W3-5

1. Use NEMA 13 enclosures for applications requiring NEMA 1.
2. Protective watertight boots are not required for indoor (non-freezing) applications. If for outdoor (freezing) use, order boots as separate items, from page D17.

D

100T

Push Buttons



Assembled Selector Switches

Assembled Selector Switches, Including Contact Blocks as shown

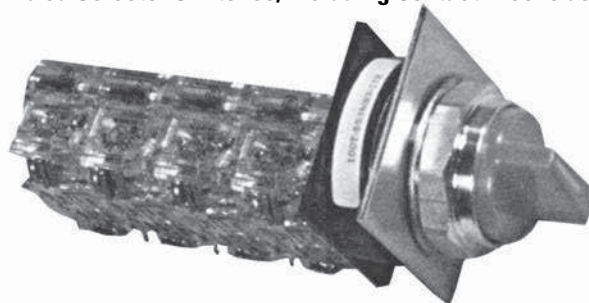

2 Position Selector Switch (Does not include Legend Plate)

Type	Location (Front View)	Contacts		Selector Position (Front View)			Complete Catalog No. and for Assembled Unit	
		Type and Symbol	Rod Color	Left	Center	Right	Black Knob Operator Catalog No.	Chrome Lever Operator Catalog No.
				←	↑	→		
2 Position Maintained	Left	N.O. ○ ○	Green	○	—	X	100T-	100T-
		N.C. ○ ○	Red	X	—	○	SS2MB1-11X	SL2MC1-11X
2 Position Spring Return Right to Center	Left	N.O. ○ ○	Green	—	○	X	100T-	100T-
		N.C. ○ ○	Red	—	X	○	SS2RB1-11X	SL2RC1-11X

3 Position Selector Switch (Does not include Legend Plate)

Type	Location (Front View)	Contacts		Selector Position (Front View)			Complete Catalog No. and for Assembled Unit	
		Type and Symbol	Rod Color	Left	Center	Right	Black Knob Operator Catalog No.	Chrome Lever Operator Catalog No.
				←	↑	→		
3 Position Maintained	Left	N.O. ○ ○	Green	○	○	X	100T-	100T-
		N.C. ○ ○	Red	X	○	○	SS3MB3-11X	SL3MC3-11X
3 Position Spring Return Right & Left to Center	Left	N.O. ○ ○	Green	○	○	X	100T-	100T-
		N.C. ○ ○	Red	X	○	○	SS3BB3-11X	SL3BC3-11X

4 Position Selector Switch (Does not include Legend Plate)

Type	Location (Front View)	Contacts		Selector Position (Front View)				Complete Catalog No. and for Assembled Unit	
		Type and Symbol	Rod Color	Left	Left Center	Right Center	Right	Black Knob Operator Catalog No.	Chrome Lever Operator Catalog No.
				←	↙	↘	→		
4 Position Maintained	Left	N.O. ○ ○	Green	○	○	X	○	100T- SS4MB8-22X	100T- SL4MC8-22X
		N.C. ○ ○	Red	X	○	○	○		
	Left	N.O. ○ ○	Green	○	X	○	○		
		N.C. ○ ○	Red	○	○	○	X		

Separate Enclosures

NEMA Type 13, and NEMA Type 4 Stainless Steel surface mounting enclosures are available with from one through sixteen element openings. All enclosures will accommodate non-illuminated operators with up to two contact blocks (1 per side). Consult factory for stations with 7 through 16 elements.

NEMA 13, Sheet Steel NEMA 4, Stainless Steel

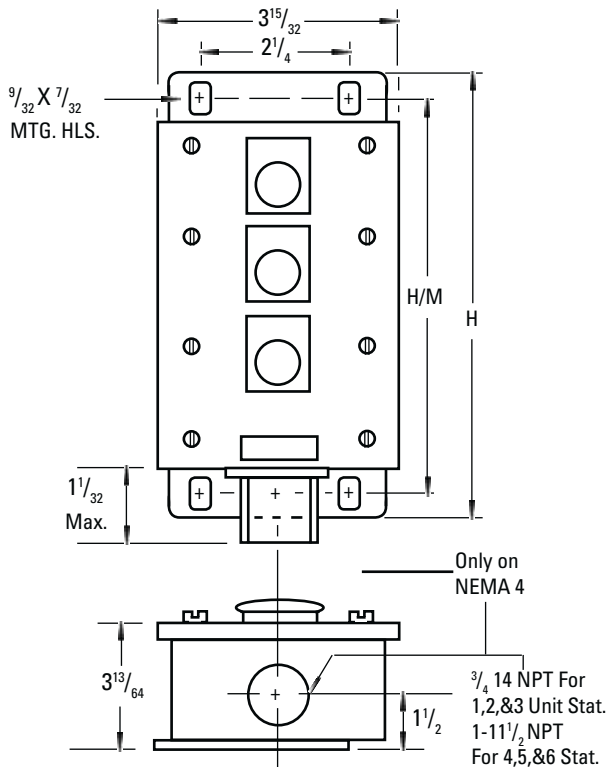

Separate Enclosures

Enclosures Only, Without Elements		
	NEMA 13 ¹ Sheet Steel Surface Mounted Enclosure	NEMA 4 ² Stainless Steel Surface Mounted Enclosure
Number Of Elements	Catalog Number	Catalog Number
1	100T-S1	100T-W1
2	100T-S2	100T-W2
3	100T-S3	100T-W3
4	100T-S4	100T-W4
5	100T-S5	100T-W5

1. Use NEMA 13 enclosures for applications requiring NEMA 1.
2. Protective watertight boots are not required for indoor (non-freezing) applications.
If for outdoor (freezing) use, order boots as separate items from page D17.

NEMA 13, Sheet Steel					
Number of Elements	Surface Mounted Enclosure				
	W	H	D	W/M	H/M
1		6-13/16			6-1/4
2		6-13/16			6-1/4
3	3-15/32	9-1/16	3-13/64	2-1/4	8-1/2
4		11-5/16			10-3/4
5		15-1/16			14-1/2

NEMA 4, Stainless Steel					
Number of Elements	Surface Mounted Enclosure				
	W	H	D	W/M	H/M
1		6-13/16			6-1/4
2		9-1/16			8-1/2
3	3-15/32	11-5/16	3-13/64	2-1/4	10-3/4
4		13-3/16			12-5/8
5		15-1/16			14-1/2

Ordering Information

- Select enclosure desired by catalog number.
- Select Pilot Devices from 100T section.

100T

Push Buttons

Legend Plates

Standard Legend Plates - Available with markings listed below.

Non-Standard Legend Plates - Can be provided with special markings.

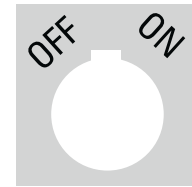
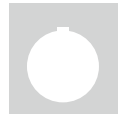
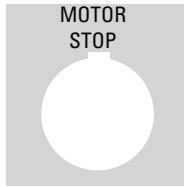

D

Marking	Catalog No. Standard Size 1-7/8" Square ¹	Catalog No. Jumbo Size 2-1/2" Square ²
For Push Buttons and Pilot Devices		
Start	100T-L01	100HF-N701
Stop	100T-L02	100HF-N702
Fast	100T-L03	100HF-N703
Slow	100T-L04	100HF-N704
Open	100T-L05	100HF-N705
Close	100T-L06	100HF-N706
Off	100T-L07	100HF-N707
On	100T-L08	100HF-N708
Up	100T-L09	100HF-N709
Down	100T-L10	100HF-N710
Raise	100T-L11	100HF-N711
Lower	100T-L12	100HF-N712
Low	100T-L13	100HF-N713
High	100T-L14	100HF-N714
Out	100T-L15	100HF-N715
In	100T-L16	100HF-N716
Jog	100T-L17	100HF-N717
Inch	100T-L18	100HF-N718
Reset	100T-L19	100HF-N719
Run	100T-L20	100HF-N720
Forward	100T-L21	100HF-N721
Reverse	100T-L22	100HF-N722
Jog Forward	100T-L23	100HF-N723
Jog Reverse	100T-L24	100HF-N724
Emergency Stop	100T-L25	100HF-N725
Push Stop		
Pull Start	100T-L41	100HF-N741
Cycle Start	100T-L83	100HF-N783
Cycle Stop	100T-L84	100HF-N784
Power On	100T-L91	100HF-N791
Motor Run	100T-L92	100HF-N792
Motor Stop	100T-L93	100HF-N793
Light Indicates Motor Running	100T-L94	100HF-N794
(Blank)	100T-L30	100HF-N730

Marking	Catalog No. Standard Size 1-7/8" Square ¹	Catalog No. Jumbo Size 2-1/2" Square ²
For Two Position Selector Switches		
Man-Auto	100T-L51	100HF-N751
Off-On	100T-L52	100HF-N752
For-Rev	100T-L53	100HF-N753
Safe-Run	100T-L54	100HF-N754
Jog-Run	100T-L55	100HF-N755
High-Low	100T-L56	100HF-N756
Open-Close	100T-L57	100HF-N757
Up-Down	100T-L58	100HF-N758
Hand-Auto	100T-L59	100HF-N759
Start-Stop	100T-L60	100HF-N760
Run-Jog	100T-L61	100HF-N761
Start-Jog	100T-L62	100HF-N762
For Three Position Selector Switch		
Hand-Off-Auto	100T-L71	100HF-N771
Auto-Off-Hand	100T-L72	100HF-N772
For-Off-Rev	100T-L73	100HF-N773
Open-Off-Close	100T-L74	100HF-N774
Man-Off-Close	100T-L75	100HF-N775
For-Safe-Rev	100T-L76	100HF-N776
Run-Safe-Jog	100T-L77	100HF-N777
Jog-Safe-Run	100T-L78	100HF-N778
Up-Off-Down	100T-L79	100HF-N779
For Four Position Selector Switches		
1-2-3-4	100T-L31	100HF-N731
For Joy Stick Operator		
(Blank)	100T-L30	100HF-N730

1. Character height is 1/8 inch on Standard Legend Plate.



2. Character height is 1/4 inch on Jumbo Legend Plate.

Notes:

Use the trim washer if no legend plate is used. Discard the trim washer when using a legend plate.



Accessories

Description		Catalog Number
	Guard Rings for Push Buttons Unguarded Guarded Extended Guard Standard Mushroom Head Guard Jumbo Head Guard Half Guarded	100T-1GR 100T-2GR 100T-3GR 100T-4GR 100T-5GR 100T-7GR
	Lens Guard for Press-To-Test Pilot Lights Plastic Metal	100T-PGR 100T-MGR
	Water Resistant Boots for Push Buttons Black Red Green Yellow Translucent	100T-PBB 100T-PBR 100T-PBG 100T-PBY 100T-PBT
	Translucent Water Resistant Boots for Illuminated Push Buttons, Pilot Lights, and Press-To-Test Pilot Lights	100T-PLTB

D

100T

Push Buttons



Dimensions and Ratings

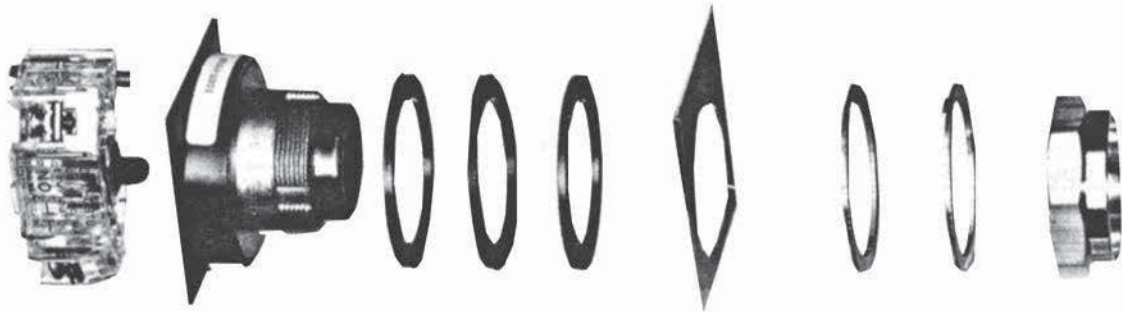

D

Minimum Centerline Clearance

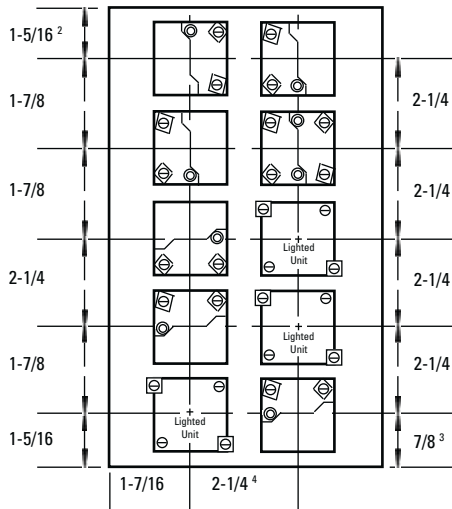

Enclosure or grounded metal part

Panel Drilling

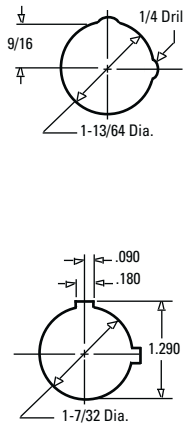

Contact Ratings

NEMA Rating	Max. Volts	Amp. Rating			VA.	
		Make	Break	Continuous	Make	Break
Maximum A-C Contact Rating Per Pole, 50 or 60 Hertz						
A600	120	60	6	10	7200	720
	240	30	3			
	480	15	1.5			
	600	12	1.2			
Maximum D-C Contact Rating Per Pole						
P600	125	1.1			5	138
	250	0.55				138
	301-600	0.2				120

Max. Panel Thickness, In.	Spacers Required
1/16	3
1/8	2
3/16	1

Panels thicker than 3/16" must be Counter Bored

Depth Behind Panel	Push Buttons & Selector Switches	Push-Pull Units (Non-Illuminated)	Illuminated Units (all)
A ⁵	21/32	1-11/32	11/16
B	---	---	1-3/32
C ⁶	3/4	3/4	3/4

Notes:

1. Use the trim washer if no legend plate is used. Discard the trim washer when using a legend plate.
2. Must be 1-5/8" for 100-HF Legend Plate
3. Must be 1-1/8" for 2-1/4" Mushroom Head
4. When using 100-HF Legend Plate, both horizontal and vertical centerlines between operators must be 2-1/2" min.
5. When using either 2-1/4" mushroom head or lever selector switch, both horizontal and vertical centerlines between operators must be 2-1/4" min.
6. Depth when three neoprene spacers are used. Reduce depth by 1/16 inch for each spacer omitted.
7. Depth per contact block. Maximum contact stack depth is three (3) inches.

Rear of Mounting Panel

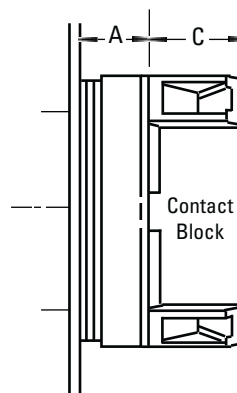

Rear of Mounting Panel

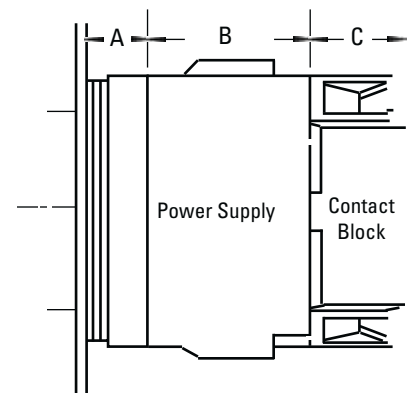

Catalog Numbering System

Push Button & Push-Pull

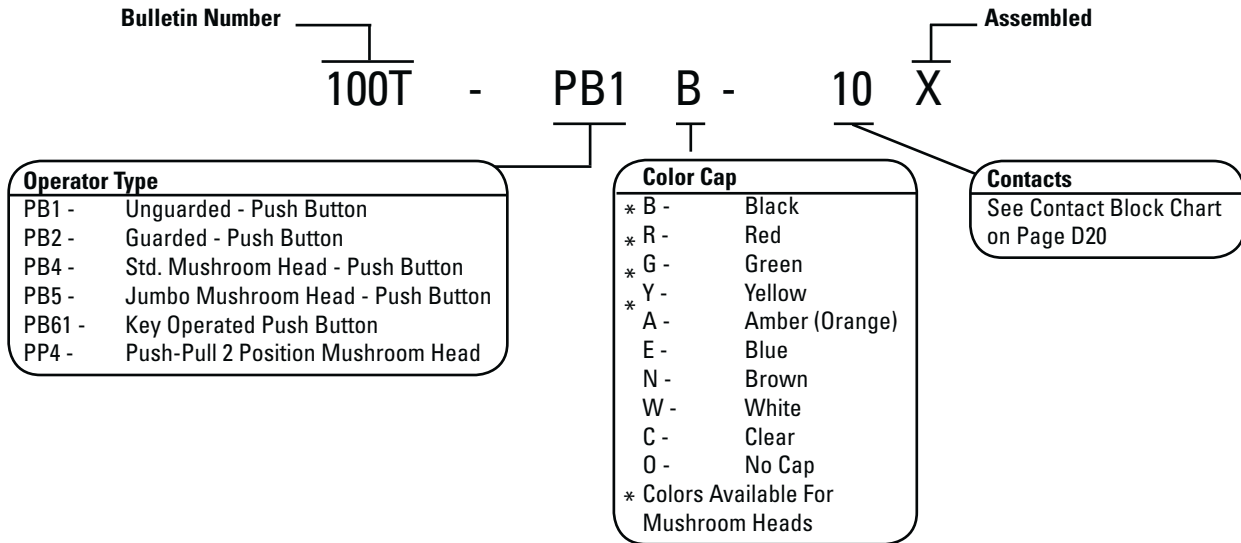

Selector Switch

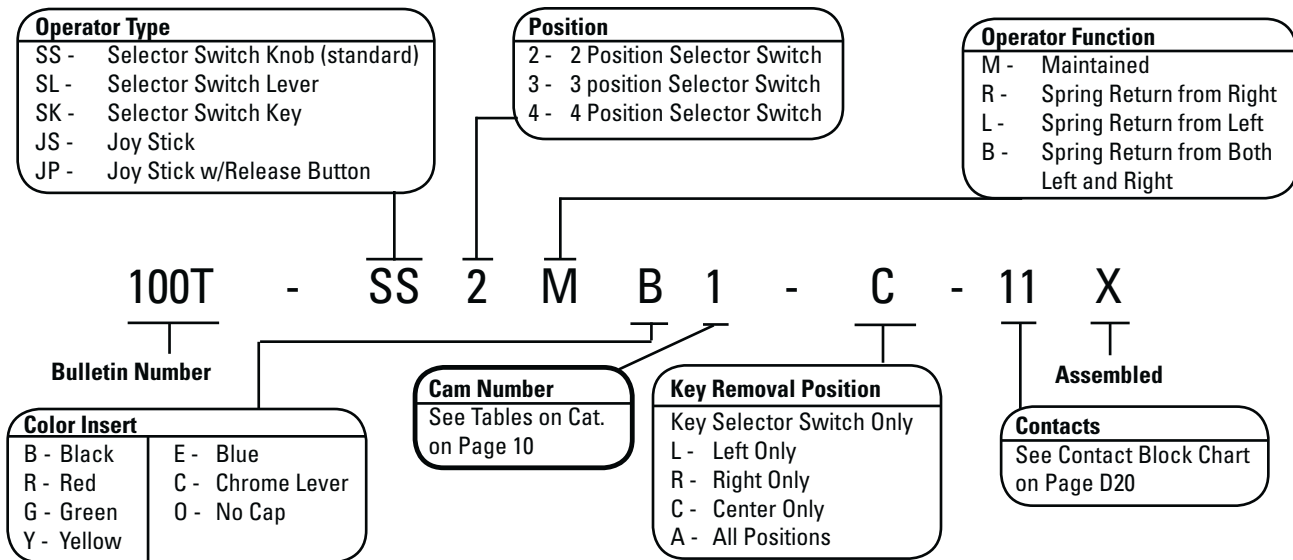

Pilot Lights & Press To Test Lights

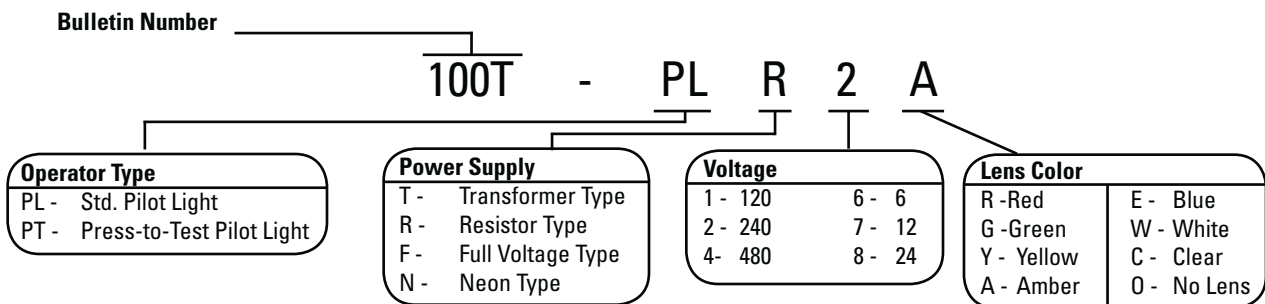

Catalog Numbering System

Illuminated Push Button & Push-Pull

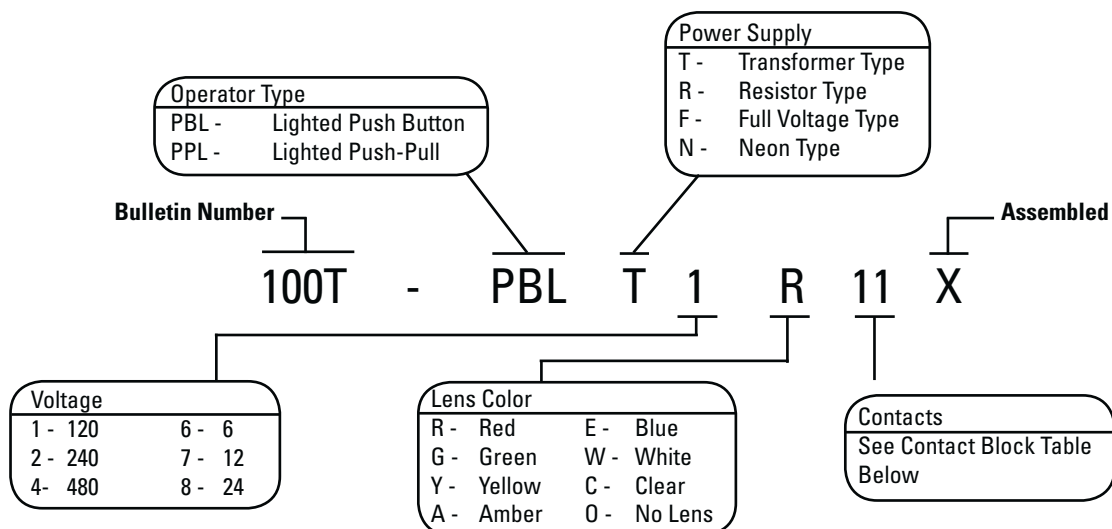

Illuminated Selector Switch

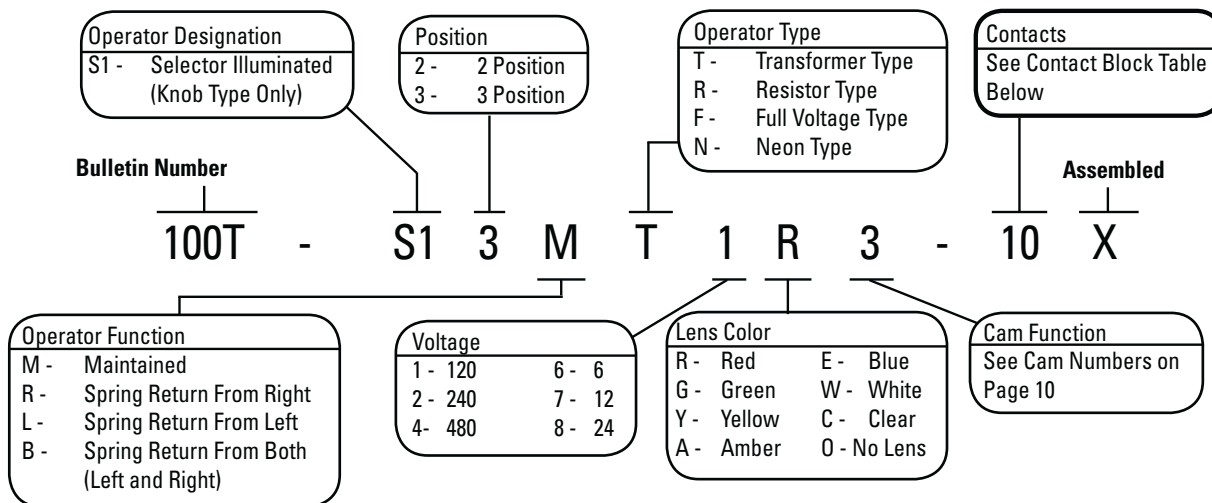

Contact Table

For This Contact Arrangement	Catalog Suffix Code	To Order These As Separate Units	
		Qty.	Catalog No.
1 N.O.	-10	1	100T-CB10
1 N.C.	-01	1	100T-CB01
2 N.O.	-20	2	100T-CB10
2 N.C.	-02	2	100T-CB01
1 N.O., 1 N.C.	-11	1	100T-CB11
2 N.O., 2 N.C.	-22	2	100T-CB11

Contact Ratings

NEMA Rating	Max. Volts	Amp. Rating		Va.		
		Make	Break	Continuous	Make	Break
Maximum A-C Contact Rating Per Pole, 50 or 60 Hertz						
A600	120	60	6	10	7200	720
	240	30	3			
	480	15	1.5			
	600	12	1.2			
Maximum D-C Contact Rating Per Pole						
P600	125	1.1	5	138	138	120
	250	0.55				
	301-600	0.2				